



Distributed by Silhouette America, Inc.

www.silhouetteamerica.com

Table of Contents

Silhouette Studio Software

Software Usage Agreement	3
Registered Trademarks	3
Disclaimer	3
About this manual	3
1. General Information	4
1.1 System Requirements.....	4
1.2 Features Overview.....	4
1.3 Software File Formats.....	5
1.4 Available digital content.....	5
2. Installing Silhouette Studio.....	6
2.1 Installing on PC.....	6
2.2 Installing on Mac.....	6
3. Basic Software Overview.....	7
3.1 Opening the Software.....	7
3.2 Software Sections.....	7
3.3 Cutting/Drawing area.....	8
3.4 Opening Documents.....	9
3.5 Document Tabs.....	9
3.6 Document Sizes.....	9
3.7 Cutting Orientation.....	11
3.8 Viewing & Zooming.....	12
3.9 Preferences.....	13
4. Drawing/Editing Images	14
4.1 Basic Drawing Tools.....	14
4.2 Editing Images.....	15
4.3 Lines Tools	17
4.4 Fill Tools.....	19
5. Text.....	20
5.1 Creating Text.....	20
5.2 Manipulating Text	21

6. Manipulating Images.....	22
6.1 Basics.....	22
6.2 Grouping/Ungrouping.....	24
6.3 Compound Paths.....	25
6.4 Moving Images.....	27
6.5 Rotating.....	27
6.6 Sizing	27
6.7 Mirroring.....	29
6.8 Arranging.....	30
6.9 Aligning.....	31
6.10 Replicating.....	32
6.11 Welding & Modify Options.....	33
6.12 Offset Options.....	35
7. Library & Online Store.....	36
7.1 Library.....	36
7.2 Online Store.....	38
8. Saving	41
8.1 Saving Options.....	41
9. Cutting/Sketching.....	42
9.1 Cut Settings.....	42
9.2 Performing a Test Cut.....	43
9.3 Cutting / Sketching.....	43
10. Print & Cut	45
10.1 Registration Marks.....	45
10.2 Cutting Printed Images.....	45
11. Troubleshooting	47
11.1 Common Troubleshooting Tips.....	47
11.2 Further Support Contact Information.....	49
Index	50

Software Usage Agreement

Silhouette America Corporation ("Silhouette America") hereby grants the purchaser and authorized User (the "User") the right to use the software (the "Software") in accordance with the terms and conditions specified. By its purchase and/or use of the Software, the User hereby accepts and agrees to abide by the terms and conditions set forth herein.

1. Copyrights

All copyrights relating to the Software and accompanying printed materials such as manuals shall be retained by the individuals or organizations indicated in the Software or printed material.

2. License

The User may use the Software on one computer at a time.

3. Copying and modification

- (1) The User may copy the Software for backup purposes.
- (2) The User may not modify, combine, amend, or otherwise adapt the Software by any means, including disassembly and decompiling.

4. Third-party use

The User may not transfer, assign, or otherwise dispose of the rights relating to the Software or its use to third parties.

5. Warranty

- (1) Should the Software not operate correctly due to physical defects in the Software installation CD, contact Silhouette America. The Software CD will be exchanged in the case of a physical manufacturing defect, or a link to download the software will alternately be provided at Silhouette America's discretion.
- (2) Silhouette America only guarantees the CD under the above situation.
- (3) Silhouette America provides the Software on an "as is" basis. Neither Silhouette America nor the supplier guarantees the performance or results that may be achieved using the Software and accompanying documentation. Neither Silhouette America nor the supplier gives any explicit or implicit guarantees regarding the infringement of a third party's rights arising from the use of the Software or accompanying manuals, their commercial performance, or their suitability for specific purposes. Neither Silhouette America nor the supplier assumes any responsibility for incidental,

secondary, or special damages resulting from the use of the Software or accompanying manuals under any circumstances, including cases in which the possibility of that particular damage arising is indicated to the User by the retailer. Moreover, neither Silhouette America nor the supplier assumes any responsibility for claims from third parties.

Registered Trademarks

The company names and product names described in this manual are registered trademarks of their respective owners.

Disclaimer

Some of the software images used in this manual are those that were used when the software was under development, and they may be slightly different from those actually displayed. There are no differences between the functions and setting layouts shown here and those of the actual version.

About this Manual

This manual is intended to provide an overview on how to use the Silhouette Studio software. While other cutting devices may be compatible, this manual assumes the use of the Silhouette or Silhouette SD digital cutting units. Instructions on using the Silhouette cutting unit may be found in subsequent manuals regarding the Silhouette hardware itself, including instructions on setting up the Silhouette for cutting or sketching, loading materials, and using the SD card feature (Silhouette SD model only) to cut directly from the Silhouette hardware device.

- (1) The contents of this manual may not be copied in part or in whole without permission.
- (2) The details and product specifications in this manual are subject to change without notice.
- (3) The greatest effort has been taken to ensure the clarity and accuracy of the information in this manual. Please contact Silhouette America or your retailer with any questions you may have.
- (4) Please note that Silhouette America assumes no responsibility for any liabilities arising out of the use of this manual and product.

1. General Information

Silhouette Studio is drawing/editing/output software that enables the creation of outline and print data consisting of objects and text, and the output of the created data to the Silhouette Digital Craft Cutter for a variety of applications including cutting and perforating media materials for 2-dimensional projects, fabricating 3-dimensional fold-together models from cut-out templates, and sketching line art. The software is compatible with all Silhouette models. The software also interfaces with other Graphtec plotter models CC100 – CC300 series models. Features and cutting results cannot be guaranteed for compatible plotter units or digital cutting units not offered by Silhouette America. Some features, such as Print & Cut applications, may not be available for other compatible cutting units not offered by Silhouette America. Silhouette Studio also supports convenient functions that enable the capturing of image data into the software and the automatic creation of registration marks for Print & Cut applications.

1.1 System Requirements

The following system environment is required to use Silhouette Studio.

Operating System:

Windows –XP/Vista/7 (32-bit & 64-bit)

Mac – OS X 10.5.8 or later

CPU: Pentium III 800 MHz or higher

Memory: 1Gb RAM recommended

Monitor: 1024 x 768 True color recommended (*compact button mode available for notebook computers*)

Mouse and/or **Graphic Tablet**

CD-ROM drive (*for installation*)

Supported cutting unit: Silhouette (*original*), Silhouette SD, Craft ROBO, and Graphtec models (CC100-20, CC200-20, CC300L-20/CC330L-20)

Supported printers: Windows-compatible or Mac-compatible printers (*inkjet printers strongly recommended for Print & Cut applications*)

1.2 Features Overview

The Silhouette Studio software includes, but is *not* limited to, the following software features and benefits:

- Imports a variety of file formats
- Print & Cut technology (*requires printer*)
- Download exclusive digital content
- Organize and optimize the library collection of images
- Cut TTF (True Type Font) files already installed on your computer
- Manipulate Text with:
 - Word and letter wrapping
 - Alignment justification
 - Letter spacing control
- Draw your own images in printing and cutting formats, including
 - Lines
 - Circles & Squares
 - Polygons & Curved lines
 - Free-hand drawing tool
- Resize images to exact specifications
- Un-group/Group sets of lines for manipulation
- Edit and manipulate points of text and images
- Erase image parts with freehand eraser tool
- Weld images together
- Create offset matted effects
- Arrange images with following abilities:
 - Transform
 - Rotate
 - Align
 - Replicate
 - Modify
- Manipulate line types for differing cutting actions
- Create your own *Print & Cut* images by filling images with custom colors, gradients, pattern fills
- Unlimited “Undo” and “Redo” actions

1.3 Software File Formats

The Silhouette Studio software uses a proprietary **.STUDIO** file format, which consist of *vector* art for line and color/gradient fill type data intended for printing and/or cutting. The Silhouette also is able to open* the following *vector* file formats in a *Ready to Cut* format:

- **GSD/GST** (*ROBO Master* program files)
- **DXF****

The Silhouette Studio software can also import some other *vector* and *raster* file formats for the purpose of being able to manually trace these images with the drawing tools***. The following additional file types can be imported:

- **JPG**
- **BMP**
- **PNG**
- **GIF**
- **WMF**

In addition to files that may be opened or imported, Silhouette Studio can also access font files in **TTF** (True Type Font) format. Please note that Silhouette America cannot guarantee the quality or success of fonts not offered by our company as not all fonts are designed with cutting or sketching in mind.

You are also able to create your own images to cut with the Silhouette software. There are simple line drawing functions built into the Silhouette software that will allow you to do so from within the Silhouette program.

*Not all features of these file types may be able to be imported into the Silhouette Studio software.

**DXF import ability not yet available. Scheduled for November 2010 release.

*** *Auto-Trace* ability not yet available. Scheduled for November 2010 release.

1.4 Available Digital Content

The Silhouette Studio software comes pre-loaded with 50 ready-made designs. These are immediately available by accessing your library.



Additional content is available through the Silhouette Online Store (*accessed through the Silhouette Studio software*). The online store will allow you to access and purchase additional digital content for the software, available both from Silhouette America artists as well as independent artists and various companies, thus ensuring a variety in look and feel of available pre-made content. Further information on the store and downloading content will be provided later in this manual.

2. Installing Silhouette Studio

2.1 Installing on PC

1. Insert the installation CD into your computer's CD-ROM drive.
 2. **Windows Vista and Windows 7 users:** You may need to allow permission to run the installer program that is automatically launched, or select to *Run SilhouetteInstaller.exe* if given the option to do so.
 3. When the installer is launched, click *Next* proceed.
 4. The license agreement will then be displayed. Carefully read and review the information provided and then click on *Yes* to continue the installation process.
 5. Continue to follow the prompts to install to the desired directory and complete the installation process.
- NOTE FOR WINDOWS USERS ONLY:** Upon hooking up the USB cord from the Silhouette tool to your computer and powering on the Silhouette unit, you may be prompted with a "New Hardware Wizard" to install a driver. You may proceed to automatically find and install the driver as located on the installation CD. The driver is *not* required for proper operation of the Silhouette Studio software, but may be installed to resolve the Windows automatic "Plug and Play" feature of prompting to install a driver for the hardware whenever the Silhouette is powered on.

2.2 Installing on Mac

1. Insert the installation CD into your computer's disc drive.
2. Drag and drop the *Silhouette Studio* program into your Application folder to launch the installation process.
3. The license agreement will then be displayed. Carefully read and review the information provided and then click on *Yes* to continue to complete the installation process.

3. Basic Software Overview

3.1 Opening the Software

To open the software on **PC**, locate the desktop icon and double-click, or if one was opted be created during installation, go to the Windows *Start* menu and select to run Silhouette Studio.

To open the software on **Mac**, open the Applications folder and launch *Silhouette Studio*.

The Silhouette Studio icon will appear as follows:



Once opened, the software should show an available starting document and workspace as shown below:

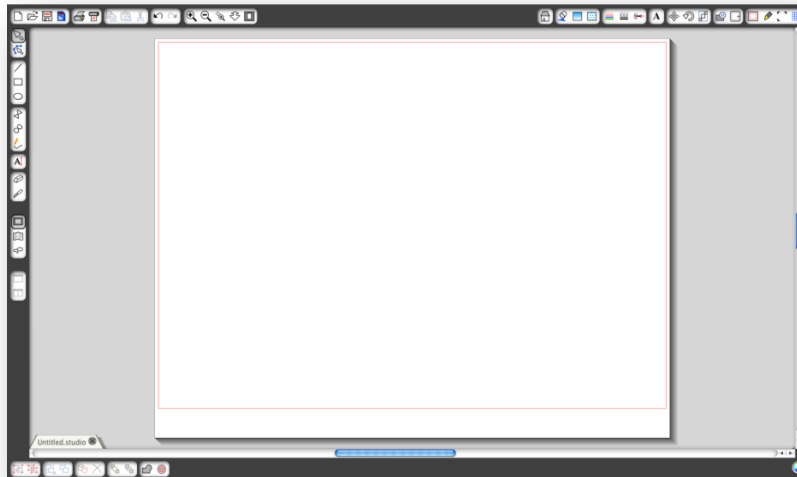

3.2 Software Sections

The software offers several sectioned areas. Details as to each button's specific function are discussed in later sections. However, so that you may be familiarized with where everything is located, a brief overview is provided for each of the sections.

General Document Management



This section along the top left-hand side of the screen is for general document management functions, such as opening, saving, and sending documents to a printer or your Silhouette digital cutting unit.

Standard Editing Tools



This section along the top left-hand side of the screen is for basic copy/paste/cut and undo/redo actions commonly found in many programs.

Zooming Tools



This section along the top left-hand side of the screen is for basic zoom-in or zoom-out functions to view parts of the document from a closer perspective or at a more distant range.

Silhouette Studio Tools



This section along the top right-hand side of the screen provides a range of tools for filling images, altering lines, adjusting text attributes, adjusting the location, angle, and size of images, and adjusting page attributes.

Drawing Tools



This section along the left-hand side of the screen provides tools used for selecting, and drawing images as well as the ability to drop text directly into your workspace area.

Library and Store Tools



This section along the left-hand side of the screen provides tools used for accessing the library and online store section.

Image Manipulation Tools



This section along the bottom of the screen provides a range of tools for grouping and selecting images, duplicating and deleting items, image placement priority (such as bringing images to the forefront or sending them to the back behind other images), welding, and offsetting.

3.3 Cutting/Drawing Area

You will note there are two different sections in your workspace:

- White workspace
- Grey holding area

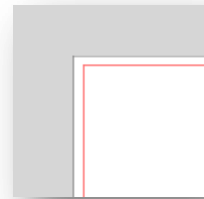

The white workspace notes the active document area. Images may be placed or drawn onto this area, or they may be placed or drawn in the grey holding area. Any images in this grey area are invisible to your cutting unit or printer. You may wish to place images off to the side to be set aside as you do not wish to include them in your job to be printed and/or cut.

You will note a red border inside this white workspace. The red line represents the active cutting area. The cutting unit will only be able to see and be able to cut what is inside this red line. All images being sent to the Silhouette to cut should be within this red line area.

3.4 Opening Documents

Though opening the software will always provide you with a new document, you may select a new workspace to start a new project at any time. To start a new document you may either use the *New* option from the File menu, or select the *New* icon:



To open existing files you may either use the *Open* option from the File menu, or select the *Open* icon:



You will then be prompted to navigate to the location where your desired file is located. Through the *Open* feature, the Silhouette Studio software has the ability to open the following cutting files:

- **STUDIO** (Silhouette Studio files)
- **GSD/GST** (Graphtec “ROBO Master” program files)
- **DXF** **

** DXF import ability not yet available. Scheduled for November 2010 release.

The *Open* feature can also access the following image file types that are not in cutting format, but may be imported for printing purposes:

- **WMF**
- **JPG**
- **BMP**
- **PNG**

A list of recently used documents may also be accessed from the File menu under *Open Recent*.

You may also use the *Merge* option from the *File* menu to open any STUDIO or GSD/GST file into the same workspace you are using rather than opening a new document workspace.

Finally, compatible file types may also be accessed by dragging the file from your computer directly onto your workspace in the software.

3.5 Document Tabs

Each new document or opened document will provide you with a new document tab at the bottom left hand corner of your screen.



The tab will be labeled as “Untitled” until you save your file with a name, or if you have opened a file that already had a name, in which case the file’s name will be displayed. The white tab will always be the active document while all other opened inactive documents will be grey. You may click on any inactive tabs to make it the active workspace and toggle between open documents. Clicking on the “X” will close any open workspace.

3.6 Document Sizes

When a new document is opened, the default document size will always start at a standard Letter size (8 ½” x 11”).

To adjust your document size to another setting, you may either use the *Page Tools* option from the View menu, or select the *Page Tools* icon:



The *Page Tools* will allow you to alter the width or length of your document. There are pre-set common sizes you may select, or you may set

measurements manually for any custom page sizes of material you may wish to use.

With custom page sizes the *width* may be adjusted up to a maximum 8 ½ inch material width. The minimum recommended width for a custom size is 3 inches. The *height* may be adjusted up to any desired measurement. However, the maximum recommended height is 40 inches. While longer materials ranges may be selected, lengths exceeding 40 inches may have the possibility of becoming misaligned on the Silhouette machine's rollers as the cutting process continues beyond this maximum recommendation. The minimum recommended height for a custom size is 3 inches.

While viewing the *Page Settings* menu, if your material is sized to fit onto the carrier sheet, the carrier sheet will be displayed to help you see how your material may be placed onto the carrier sheet to feed into the Silhouette when it is time to cut. Later, as you go to cut, this will also be displayed to help ensure you are feeding your material into the Silhouette correctly. This carrier sheet animation may be selected to always be displayed under the *Preferences* settings (discussed in section 3.9).

When the carrier sheet is shown, you may select the *Reveal Carrier Sheet* option in the *Page Settings* menu in order to show exactly on your mat where images will be cut in reference to the grid that is printed on the actual carrier sheet.

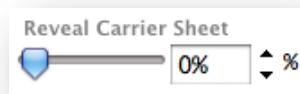

As you slide the bar to the right or increase the percentage number, the white page workspace will become more transparent and show the carrier sheet beneath. A setting of 100%, or having this bar slid all the way to the right, will allow you to see the carrier sheet completely and your white workspace will be entirely transparent.

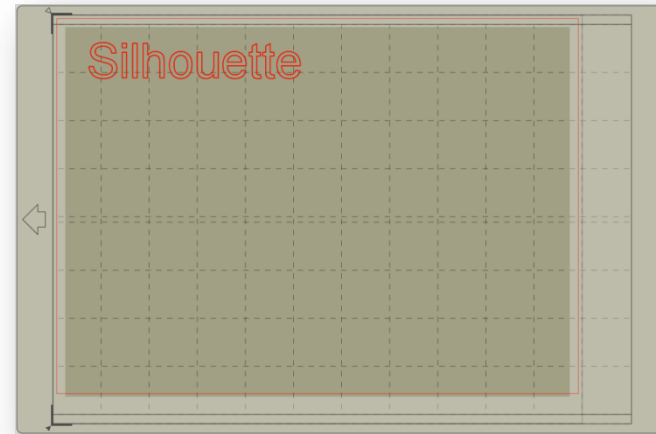

When viewing in this manner, the red line will still represent your cutting area. Images falling outside of this red cutting area will not be cut. The darker area on the carrier sheet represents your printer's print margin area and is only for reference.

3.7 Cutting Orientation

Documents may be viewed in Landscape or Portrait orientation. Depending on how you may wish to view your workspace, images being sent to the Silhouette will vary based on your orientation.

Landscape is the default orientation whenever a new document is opened.

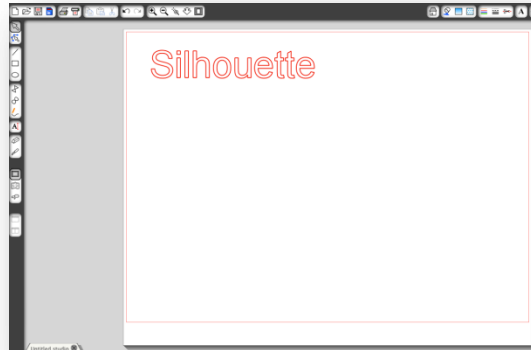

When a document is in landscape orientation, it will be sent to the Silhouette with the upper left-hand corner of the screen coinciding with the upper right-hand side of your material, as seen below:



Portrait orientation is an optional orientation that may be switched to through the *Page Tools*. Using this orientation will provide you with a screen that appears as the following:

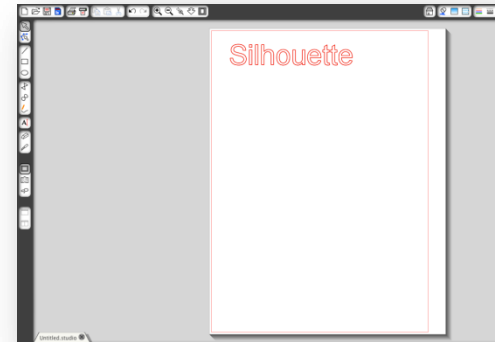

When a document is in portrait orientation, it will be sent to the Silhouette with the upper right-hand corner of the screen matching the upper-right hand side of your material, as seen below:

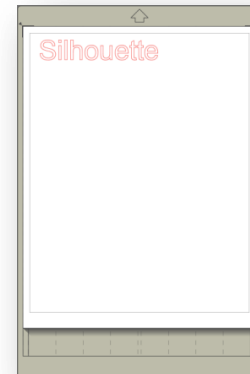

The *Page Tools* also provides the ability to rotate how you are viewing your page. While the *Page Orientation* will dictate the way your cutting job is being sent to the Silhouette to cut, the *Rotate View* option will simply rotate your workspace on the screen for a different perspective.

3.8 Viewing and Zooming

Often as you view your workspace, you may either wish to zoom in to get a closer look at smaller images or parts of an image that may be more difficult to work with.

Zoom In



This tool will zoom into the center of your workspace for a closer view.

Zoom Out



This tool will zoom out from your view for a more broad perspective.

Selection Zoom



This tool will allow you to zoom to specific areas of your workspace by drawing a box around the area you wish to zoom into.

Drag Zoom



After clicking on this tool, your icon will appear as the *Drag Zoom* icon above. You may then click and hold down your mouse to zoom in or out manually to any selected scale.

Fit to Page



Clicking the *Fit to Page* icon will immediately fit the full defined workspace to the center of your screen.

3.9 Preferences

There are a number of user-controlled options that may be found in the File menu (PC) or Silhouette Studio menu (Mac) under *Preferences*.

Defaults

This section will allow you to adjust the default settings when Silhouette Studio software is opened. You may opt to adjust the following defaulted settings depending on your personal preferences:

- **Drawing Preferences** –Includes the ability to determine the program’s behavior of how a shape is created and whether after a new shape is drawn the cursor will continue to draw further shapes or return to the select tool.
- **Fill Style** – Provides the ability to select how new user-drawn images are created as to whether they are displayed as an outline only (as red line images), or as solid fill images (which may be preferable for the creation of Print & Cut images that are made by the user).

- **Carrier Sheet Display Preference** – Provides the ability to always show the carrier sheet or only when sending images to cut.
- **Registration Marks Preference** – Adjust program to always have registration marks turned on or off.
- **Language** – Adjust program to specified language.
- **Page Configuration** – Define whether Landscape or Portrait orientation is desired whenever a new document is started.

General

This section provides adjusting how the program selects images, animates movements, and drawing detail options. You may opt to adjust the following:

- **Anti-aliasing** – Helps smooth jagged lines created by the freehand drawing tool. Higher sample rates will increase the smoothness of lines as they are drawn freehand. The “off” setting will produce rougher edges, but increases drawing speed.
- **Selection Preferences** – Provides options on how images are selected when enclosing multiple images in the same selection box.
- **Animation** – Controls speed of animating actions, such as images being moved on undo or redo actions, or during zooming in and out. Can be adjusted to “Instant” to turn animations off.

Measurements

This section provides options regarding units of measurement displayed in the program. You may adjust the following:

- **Unit of Length** – Adjust all displayed measurements to desired unit.
- **Dimensions** – Turn on or off image’s measurement properties as images are selected.

Buttons

Allows adjustment for larger or smaller icons displayed in the program for varying screen resolution sizes.

Advanced

This section provides some additional advanced options that may be selected. In this section, you may adjust the following:

- **HTTP Sockets** – Depending on your internet connection speed, this option may be adjusted to a higher number of sockets to increase the download speed when purchasing images from the online store.
- **Bezier Control Handle Option** – Allows whether you wish to view editing point handles for all curved lines while in Point Editing Mode, or only the handles for the active selected point.
- **Line Modification Options** – Allows users to determine how images should be shown that are modified with some of the program’s tools.
- **Background Color Preference** – Allows user to determine the color of the inactive workspace area.
- **Reindex My Library** – Performing this action will re-index the library to ensure corruption or errors may be resolved should you experience any concerns with your library loading properly or being able to use the library’s Search function properly.

Another program option not in the *Preferences* menu is the *Software Color Theme* button located in the bottom right-hand corner of the software screen.



Clicking on this button will cycle through a pre-selected list of color themes for the software’s overall appearance, should you prefer some color other than the default dark grey interface. Right-clicking on this icon will allow you determine the color scheme of the inactive area around your workspace.

4. Drawing/Editing Images

4.1 Basic Drawing Tools

Silhouette Studio allows users to draw and create images very easily through a set of basic drawing tools. All drawing tools are located on the left side of the software screen.

Line Tool



The *Line Tool* allows for the creation of single straight lines. Holding down the *Shift* key on your keyboard while drawing will force a straight vertical, horizontal, or 45-degree increment line from the start point.

Rectangle Tool



The *Rectangle Tool* allows for the creation of a square or rectangle. Holding down the *Shift* key on your keyboard while drawing will create a square, while holding down the *Alt* key on your keyboard will make the initial cursor point where your image is started as the exact center of your object.

Circle Tool



The *Circle Tool* allows for the creation of an oval or circle. Holding down the *Shift* key on your keyboard while drawing will create a circle, while

holding down the *Alt* key on your keyboard will make the initial cursor point where your image is started as the exact center of your object.

Polygon Tool



The *Polygon Tool* allows for the creation of multiple straight lines. A point will be created upon each mouse click. Lines will continue to be drawn until the image is closed by aligning the end point with the starting point, or by double-clicking the mouse to stop drawing. Holding down the *Shift* key on your keyboard while drawing will force a straight vertical, horizontal, or 45-degree increment line from the start point or last point dropped.

Curved Shape Tool



The *Curved Shape Tool* allows for the creation of multiple curved lines. A point will be created upon each mouse click. Lines will continue to be drawn until the image is closed by aligning the end point with the starting point, or by double-clicking the mouse to stop drawing.

Freehand Drawing Tool



The *Freehand Drawing Tool* allows for the creation of a continuous free-form line. Lines drawn with this tool will continue until the mouse button is released, or the image is closed by aligning the end point with the start point.

4.2 Editing Images

All line points on images may be edited, if changes to the existing image are desired.

Select Tool



The *Select Tool* determines which image is selected as the active image and allows you to move images around on your screen. This is your default tool to click on images to show they are selected.

Edit Points



To enter the *Point Editing Mode*, you may either double-click on a selected image, or use the Edit Points tool. This tool will allow you to edit any points of your image to move them around or remove them. Only single ungrouped line selections may be edited. Ungrouping will be discussed in later sections.

To exit the *Point Editing Mode*, you may double-click on your image again, or return to the regular select mode by clicking on the *Select* tool.

Point Editing Mode

When you enter the *Point Editing Mode*, selected images will change from displaying the resizing and rotating control handles around the image to showing the points, or nodes, of the image. Points on lines are where the line may take a new direction or change from being flat (or straight) to being curved.

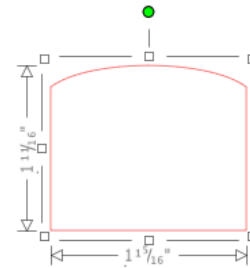

Regular Selection Mode

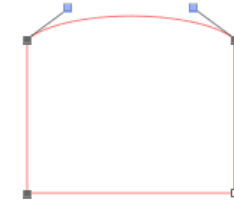

Point Editing Mode

In *Point Editing Mode*, the selected point will be displayed in white while all other points will be dark grey. The selected line associated with the selected point will be emphasized as a bolded red line. Additional lines that have blue points are handles to adjust curved lines.

In *Point Editing Mode*, you will also be shown the *Point Editing* toolbar on the right-hand side of the screen. You may do the following actions in *Point Editing Mode*:

Move/Adjust Points

Move a point by hovering with your mouse over any point on the line. Once over a point that may be edited, the cursor will adjust to show you may click and grab the point to move it to any desired location. With curved lines, you may similarly grab the blue points and drag them around the screen to adjust the curve of the associated line segment.

Add Points

Add a point by hovering over the line where no points currently exist where you may wish to drop a new point to edit your image. Once over a line where a point may be dropped, the cursor will be adjusted to show you may click to drop a point onto the desired line location.

Delete Point



Any selected point will be deleted by using the *Delete Point* tool, or by right clicking on the selected point and choosing the *Delete Point* option. Deleting a point will cause the closest points on either side of the deleted point to join and create a new connecting line. Note that this tool is different from deleting an image and is only intended to delete individual points. It will only be available while in *Point Editing Mode*.

Break Path



You may break the path of any line point by using the *Break Path* tool, or by right clicking on the selected point and choosing the *Break Path* option. Breaking a path will create two new points from the originally selected point where the path was broken.

You will note that a broken path, or two unconnected end points of opposite ends of the same line, may be re-joined by dragging one end point onto the opposite end point of the image.

Corner



The *Corner* tool will allow a selected point to be so that the control handles at the selected intersecting point can be adjusted each individually to create a sharp corner.

Smooth



The *Smooth* tool will allow a selected point to be adjusted to make a smooth transition point at the selected intersecting point.

Make Flat



The *Make Flat* option will adjust the selected line (the line emphasized in bold red that is associated with whichever currently selected point) to a flat, straight line.

Make Curve



The *Make Curve* option will adjust the selected line (the line emphasized in bold red that is associated with whichever currently selected point) to a curved line.

Simplify



Some library images or other imported images from other sources may contain a very large number of points. The *Simplify* tool will automatically

re-adjust the image's points and simplify the image to its simplest possible point form while maintaining the image's original overall line form.

Aside from the tools found in *Point Edit Mode*, there are two additional editing tools found on the left-hand side of the screen.

Eraser Tool



You may erase any part of any line image using the *Eraser* tool to easily and immediately remove inner parts or edges of the line image.



Original Image



New image using Eraser Tool

Knife Tool



You may segment images using the *Knife* tool. This tool delivers a straight-line cut to separate parts of images to create a new separate independent shape.

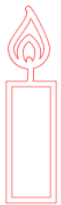

Original Image



New images from using Knife Tool

4.3 Lines Tools

Lines in the program, including text, images created using the drawing tools, and library images, may be altered to have different properties.

Line Color Options



While lines will default to be displayed in red, you may alter lines to any desired color. Altering line colors will not affect their properties in how they may cut. Altering line colors may be helpful to allow you to more easily view different images or image parts, see lines in whichever color you may prefer to view them, or adjust image parts specifically with printing in mind for Print & Cut jobs where it may be important that line colors are selected to be printed.

To adjust line colors, select your image and access the Line Color menu by clicking on the icon shown above. You may then select any of the Basic Menu color options. The hash line selection will always represent “clear”:



The *Advanced Options* menu will allow you to create lines in any desired custom color. You may either drag the target on the color spectrum to visually match the color you are looking for, or type in the *RGB* (Red Green Blue) or *HSL* (Hue Saturation Lightness) value of your desired color, if you are seeking a specific known color. You will also have the ability to adjust the transparency of the line by manually dragging the *Transparency* option bar or by typing in the desired percentage of how transparent you wish the line to be, where 0% is solid and 100% is completely clear.

Line Style Options



Lines are viewed in point sizes regarding their width. The point size may be adjusted to any desired specification. While line width may be adjusted, the line will always be cut or sketched in a fixed width; that is, according to how thick the blade or pen is that you are using. The line styles are only really used in accordance with creating image effects for Print & Cut images.

Line thickness may be adjusted by either manually dragging the *Thickness* option bar or by typing in the desired point thickness.

The *Corner Style* option will adjust how lines appear at any of the image's corner points where *Corner* is a sharp edge whereas *Rounded* will be a smoother edge.

The *End Cap Style* option will only adjust lines that have open ends, where *Flat* provides a sharper flat edge at the line tip and *Rounded* provides a smoother rounded edge to the line tip.

The *Position* option will adjust if the line is *In Front* of a filled image, or *Behind* the filled image.

Cut Style Options



The *Cut Style* option may be selected at any time to view how each line or image on your workspace is set to be cut.

When clicking on this option, your workspace will immediately emphasize all lines and their selected attributes for easy reference. To change a line's cut style, simply click on the desired image and then select the new desired line style from the list. The following line styles are available:



No Cut – This option will turn off the line from being sent to the Silhouette. While you will still be able to see it on your screen, it will be suppressed from being cut.



Cut Edge – This option will cut the outer edge of any overlapping lines and will suppress any lines with the same attribute if they are contained inside a larger image. This option may be preferable for the creation of Print & Cut images.



Cut – This option ensures the selected line will be cut regardless of where it is placed, whether overlapping or inside a larger image. Lines with this attribute will cut even if they are contained within other lines that are defined as “Cut Edge” or “Perforate Edge” line types.



Perforate Edge – This option will cut a dashed line on the outer edge of any overlapping lines and will suppress any lines with the same attribute if they are contained inside a larger image.



Perforate – This option will cut the selected with a dashed line regardless of where it is placed, whether overlapping or inside a larger image. Lines with this attribute will cut a dashed line even if they are contained within other lines that are defined as “Cut Edge” or “Perforate Edge” line types.

The *Print Cut Lines* option will enable all cut and perforate lines to be printed as they appear on the screen. Otherwise, only lines with the “No Cut” attribute will be printed when sending your document to a printer.

4.4 Fill Tools

Closed images (where the starting point of the line connects with the ending point of the line) including Text, images created using the drawing tools, and library images, may be altered to have different filled properties. Only closed images may have filled attributes. If the path is broken on any closed images, any applied fill attributes will immediately disappear.

Fill Color Options



While closed images will default to be displayed as empty, you may fill any closed image with any desired color. Altering fill colors may be helpful to allow you to more easily view different images or image parts, see shapes and text in whichever color you may prefer to view them, or adjust images specifically with printing in mind for Print & Cut jobs.

To apply fill colors, select your closed line image and access the *Fill Color* menu by clicking on the icon shown above. You may then select any of the Basic Menu color options. The hash line selection will always represent “clear”:



The *Advanced Options* menu will allow you to create fill colors in any desired custom color. You may either drag the target on the color spectrum to visually match the color you are looking for, or type in the *RGB* (Red Green Blue) or *HSL* (Hue Saturation Lightness) value of your desired color, if you are seeking a specific known color. You will also have the ability to

adjust the transparency of the filled color by manually dragging the *Transparency* option bar or by typing in the desired percentage of how transparent you wish the filled color to be, where 0% is solid and 100% is completely clear.

Fill Gradient Options



Similar to filling images with solid colors, you may also select to fill any closed line images with a gradient fill.

To apply gradient fill options, select your closed line image and access the *Fill Gradient* menu by clicking on the icon shown above. You may then select any of the Basic Menu pre-created gradient options. The hash line selection will always represent “clear”:



You may also alter the basic direction of the gradient by clicking on any of the *Direction* options at the bottom of the Basic Options panel.

The *Advanced Options* menu will allow you to create your own custom gradient fills based off of the last gradient fill selected. Gradient fills will always have a minimum of two (2) colors, with one color at the top and one color at the bottom. The gradient will then create a range between the two selected colors.



You may change either of these colors in the range by clicking on the color arrow bars on the left-hand side of this gradient creator tool. Once the color is selected, you may then select any new color from the *Select Color* tools directly below. You may also add new bars at any interval between the top and bottom colors, or slide any color bars in between the top and bottom gradient color bars up and down to create new gradient effects.

Also in the *Advanced Options* is the ability to rotate the angle of the gradient effect to any customized degree by either manually dragging the *Angle* tool or by typing in a specified degree. You will also have the ability to adjust the transparency of the line by manually dragging the *Transparency* option bar or by typing in the desired percentage of how transparent you wish the filled gradient effect to be, where 0% is solid and 100% is completely clear.

Fill Pattern Options



The final fill option is used to fill any closed line images with a pattern fill. To apply pattern fills, select your closed line image and access the *Fill Pattern* menu by clicking on the icon shown above. You may then select any of the pattern options.

Once your desired pattern fill is selected, the *Advanced Options* menu will allow you to adjust the pattern's direction *Horizontally* or *Vertically*, or

adjust to either a *Fixed* or *Stretch* aspect ratio. Options are provided in this menu to rotate the pattern by either simple pre-set degrees, or to any customized degree by either manually dragging the *Angle* tool or by typing in a specified degree.

In addition, you have the ability to scale the pattern's size to alter the pattern itself as it fills the selected shape. You may do this by either manually dragging the *Scale Pattern* bar or entering a new percentage value of how much larger or smaller you may wish to make the filled pattern.

You will also have the ability to adjust the transparency of the line by manually dragging the *Transparency* option bar or by typing in the desired percentage of how transparent you wish the filled gradient effect to be, where 0% is solid and 100% is completely clear.

Additional patterns cannot yet be downloaded and added to the pre-installed selections.

5. Text

Silhouette Studio has the ability to utilize any TTF (True Type Font) that is installed on your computer. You do not need to install these fonts into the program. Silhouette Studio will simply access all installed TTF files and display them for you as you go to create your desired text.

5.1 Creating Text

To use your fonts, click on the text tool located on the left-hand side of the software screen:



Clicking this will allow you to place a text cursor onto your workspace and begin typing directly onto the screen.



The red blinking line is your cursor to show where you are typing. You may back up or move forward by either clicking your mouse or using your computer right and left arrow keys.

The surrounding green box is your text box. This box may be adjusted by clicking and holding the black bar on the right edge of the text box. Dragging this bar to the left will allow you to wrap your text. Dragging this bar to the right will allow you to bring text back toward being on a single linear path.

You may double-click or click outside of the text to exit the Text Editing Mode. You may return at any time to re-edit any words or letters by double-clicking again on your created text.

5.2 Manipulating Text

During the creation of your text, the *Text Style* menu will be opened on the left-hand side of your screen providing multiple adjustment options.

Available Fonts

The first section of this menu will display the current selected font with additional font options that are installed on your computer you may scroll through. The top of this section may be used to search for any specific font by typing in a font name if it is known.

You may change fonts during the Text Editing Mode and use a new font within the same text box with other fonts. Different fonts may also be applied to existing text or letters during Text Editing Mode by highlighting the desired string and selecting the newly desired font. If you are not in

Text Editing Mode, new fonts may still be applied to selected text, but such adjustments will change the font for the entire selected text box.

Font Characteristics

Some fonts are programmed to enable the use of certain style characteristics allowing you to bold, italicize, or underline text or letters. These characteristics will only be highlighted to be available for selecting if the font in question is programmed with that characteristic and such characteristics can be applied. To apply one of these characteristics, you may highlight the intended letters or words and then click on the available characteristic.



While *Bold*, *Italic*, and *Underline* options are displayed, if there are any additional available options programmed for the selected font, a scroll bar will appear on the right-hand side of this option box allowing you to scroll down and view whatever other options may be programmed.

Text Justification

While text will be automatically be justified to the left, if your text is wrapped on multiple lines, you may alter your text justification as desired.

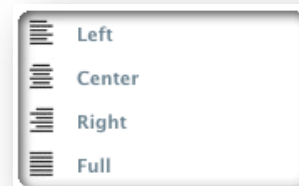

Text Size

Text size will always default to 72 point size. This refers to the font's printed font size. Though fonts vary as they are programmed by a wide variety of sources, this will generally equate to roughly a one (1) inch height (or 25 mm). The most common point sizes for print-format fonts are included in the available drop-down list, though any custom number may be manually typed into this size preference.

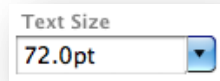

Other common equivalent measurements in the list include:

- 18 pt = 0.25 inch (6 mm)
- 24 pt = 0.33 inch (8 mm)
- 36 pt = 0.5 inch (13 mm)
- 48 pt = 0.66 inch (17 mm)
- 144 pt = 2 inches (50 mm)
- 288 pt = 4 inches (100 mm)

Again, these measurements are approximations and will vary from font to font, so if you are seeking to obtain a specific measurement, you may wish to alternately re-size your text to your desired specification after creation.

Character Spacing

Letters may be adjusted from their normally programmed spacing to either bring them closer together or push farther apart with the *Character Spacing* option.

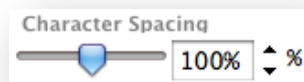

Spacing will always start at 100% indicating spacing between characters are normally distanced. As the number is lowered or the bar is slid to the left,

letters will come closer together. As the number is raised or the bar is slid to the right, letters will become spaced farther apart.

Line Spacing

If your created text is wrapped to multiple lines, you may similarly increase or decrease the *Line Spacing* option to adjust the distance between lines of text.

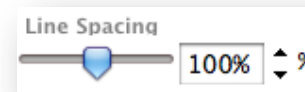

Spacing will always start at 100% indicating spacing of lines are normally distanced. As the number is lowered or the bar is slid to the left, text lines will come closer together. As the number is raised or the bar is slid to the right, text lines will become spaced farther apart.

6. Manipulating Images

There are many tools in Silhouette Studio allowing for basic and advanced manipulation of images and text. The following section provides an overview for all of these included tools and how they may be used.

6.1 Basics

Like most any software program, Silhouette Studio has a set of common basic editing tools as follows:

Selecting

Images may of course be selected by clicking on them. Multiple images may be selected by holding down the *Shift* key on your computer keyboard and clicking on another image. You may repeat this action to select as many images as desired. Holding down the *Shift* key and clicking on an image that is already selected will de-select that image.

Multiple images may be also be selected by clicking above an image and dragging your mouse to enclose all desired shapes to be selected at the same time. As you hold your mouse button down and drag your mouse, you will see a dashed line creating a selection box showing what you are selecting. Upon letting go of your mouse, all enclosed images in this box will be selected together in the same bounding box.

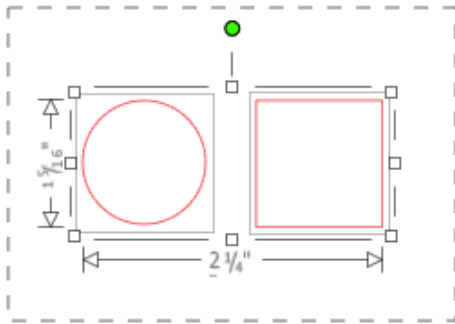

If you wish to select all available images on the screen together, you may click on the *Select All* button located along the bottom of the software screen:



Similarly, if you wish to deselect all currently selected images, you may click on the *Deselect All* button:



Copy/Paste/Cut Tools



These tools perform the basic expected actions of copying selected images, pasting them, or cutting them from view. Images copied or cut will reside in your computer's memory on a virtual clipboard. You may only have one object on this clipboard at a time. This means if you copy one image and then copy another, only the most recent image will be waiting on the clipboard to be pasted. These actions may be accessed from the top tool bar, in the *Edit* menu, or by right-clicking on an image, as well as by using standard shortcut keys for these actions.

Pasting copied images will place the copy directly to the right of your original image so you may easily see and find your copy. An additional *Paste in Front* option is also provided to be able to paste a copy of an image directly on top of itself and is found in the *Edit* menu, in the right-click menu for the selected image, or by using standard shortcuts for this action.

Duplicate



The *Duplicate* option performs the same action as copying and pasting the selected image to the side, but does so without the need of utilizing your clipboard and is a one-click operation. This toolbar button is located along the bottom of the software screen and can alternately be located in the *Edit* menu or by right-clicking on a selected image.

Delete



Selected images may be deleted from your workspace by clicking on the *Delete* button located along the bottom of the software screen, by accessing the *Edit* menu and selecting *Delete*, right-clicking a selected image and choosing the *Delete* option, or by simply pressing the *Delete* key on your computer keyboard.

Undo/Redo



Any action taken, including simply moving an image, may be undone. To back up to the previous action taken, click the *Undo* button. There are an unlimited number of actions you may go back to with the *Undo* button, including going back to when you first opened your new workspace.

Similarly, you may click the *Redo* button to repeat any actions you may have undone. You may continue to use this button until you return to the last action taken.

6.2 Grouping/Ungrouping

These two actions are commonly used and are invaluable tools for helping to manipulate and adjust images. To understand these concepts we must first understand what grouped and ungrouped images are.

The following is an example of a *single line*:

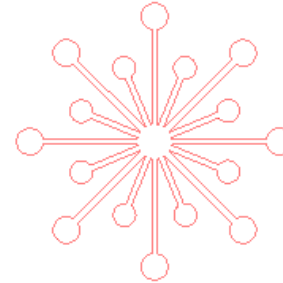

While the image may have many parts, it is still just one line with a single starting point and end point.

The following is an example of a *multiple line image*:



This image has two line sets with the body of the leaf and stem being one part and the inner details of the leaf being another. This image is grouped together so that if moved around on your screen, you do not have to move the outer line of the leaf and then move the center part independently and try to align it inside.

While it is not necessarily important to know exactly how many line parts an image has, it is important to understand that single line images are not grouped together with anything, while anything that has multiple parts is or can be grouped.

Grouping



Any two sets of lines can be grouped together so they are fixed in their relative positions, even if moved, by using the *Group* option.

To use the *Group* option, select two or more images at the same time and click on the *Group* icon located along the bottom of the software screen. This can alternately be located in the *Object* menu or by right-clicking on the multiple selected images and selecting *Group*.

Ungrouping



Any image that contains more than one line set can be ungrouped so that parts of the image may be treated independently, removed, rotated, resized, or otherwise manipulated rather than having to manipulate the image as a whole.

For example, you may wish to cut out this cake image, but want to ungroup the image in order to remove some of the inner decorations of the image:

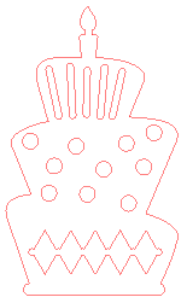

Once ungrouped, the image will be displayed showing individual selection boxes around each new ungrouped image part that can now be manipulated:

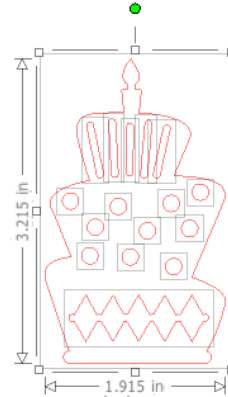

To access the individual ungrouped parts, you may unselect your image and then click onto any independent desired part for further removal or manipulation.

6.3 Compound Paths

The concept of compound paths is important in order to understand why certain attributes may be applied differently to seemingly identical situations. Compound paths are a collection of two or more line sets where inner lines are embedded into the image. A compound path may appear the same as a grouped set of lines, but is quite different in the way it will react to being filled with color, for example.

Compound paths are only really a concern when you are creating Print & Cut images.

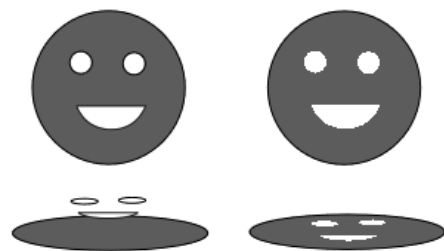

Non-compound image Compound Path image

In the examples above, the top two images are seen straight on and appear to be identical. However, when looking at the bottom set of images the differences become apparent. With the image on the left, from a side view we are actually looking at a grey circle with a set of eyes and mouth as three other separate white shapes resting on top. This is an image that is *not* a compound path. With the image on the right, from a side view we see that we are looking at a circle with two holes and a smile embedded into the image.

Of course, as we go to cut or sketch both images with the Silhouette, they will cut out in the exact same manner, but it is important to understand that there is a difference between these images as you may wish to achieve certain effects with filling images for Print & Cut applications. For example:



This is the same image unfilled. All parts are grouped together.

If this is a non-compound image and it is filled with a color feature, this will be the result:



Even though grouped together, all line sets are still just individual pieces lying on top of each other, so they are all filled with the selected fill effect.

If this image has a compound path and it is filled with a color feature, this will be the result:



The unfilled parts of the image cannot be filled with compound path images because these embedded areas are negative space.

Compound paths can still be ungrouped to move multiple image parts around, but the action of ungrouping will immediately release the compound path and make it a non-compound path image

To make a series of multiple selected images a compound path, you may right-click until the multiple parts are all selected and select *Make Compound Path*. Similarly, you may right-click on a compound image and select *Release Compound Path* to perform the opposite action. These options may also be found in the *Object* menu.

6.4 Moving Images

Images may obviously be moved by selecting them and then dragging them around the screen with your mouse to any desired location. Selected image may also be moved by using the arrow keys on your computer keyboard.

You may also move images through the *Move* menu panel.



Selected images may be moved by using any of the *Move* options. The directional arrows in this screen will move images subtly in whichever direction you select. This action may be repeated until your image is located on your workspace as desired.

The *Move By* option will move selected images from the current location by whatever measurement is entered, while the *Move To* option will move images regardless of present location to a specific plotted course on your workspace, where a measurement of 0, 0 (zero, zero) represents the upper left-hand corner of your workspace and moves out from that point either to the right or downward as the values increase.

6.5 Rotating

Objects may be rotated to any desired angle. Selected images will always appear with a green rotation handle-bar that may be manually grabbed and rotated using your mouse.

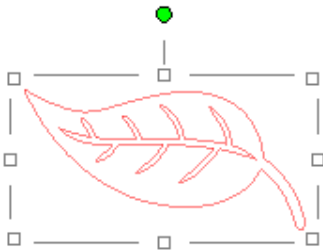

The *Rotate* menu options will also provide additional rotation options for more exact or specific rotation options.



Within the *Rotate* menu you may select any of the following options.

Rotate By

These options will rotate the selected image by the selected common angle from the image's current angle.

Rotate To

These options will rotate the selected image to the selected angle based on the image's original fixed 0° point.

Custom Rotate By

This option will allow you to either manually slide a degree measurement bar or enter a specific degree measurement and apply to rotate the selected image from the image's current angle.

Custom Rotate To

This option will allow you to either manually slide a degree measurement bar or enter a specific degree measurement and apply to rotate the selected image based on the image's original fixed 0° point.

6.6 Sizing

Objects may be sized to any desired measurement. It is important to note, however, that while you may customize images to any desired size, the quality of cuts made may vary, especially when cutting thicker materials such as cardstock. Reducing the size of an image with intricate parts and cutting it in a thicker material is an example where the cut quality could suffer.

You will be able to view the measurement alongside your image as you draw or select images.

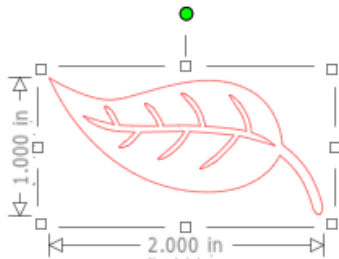

There are also control points on the selection box for resizing images manually. To resize manually, simply click on any of these boxes and drag your mouse in the desired direction to make your shape larger or smaller. The corner control points will proportionately resize the image and maintain the relative height and width, while the side control points will stretch your image in the direction your mouse is dragged.

The *Scale* menu options will also provide additional sizing options for more exact or specific rotation re-sizing options.



Within the *Scale* menu you may select any of the following abilities.

Scale

These options will resize any selected images by a percentage of its current size. Any number under 100% will make your image smaller and any number over 100% will make your image larger. For example, selecting to resize your image to 50% of the current size will make your image half as large while selecting to resize your image to 200% of the current size will make your image twice as large. Any custom percentage may be applied as desired.

Specify Dimensions

This option will allow you to resize a selected image to any specific measurement. The *Lock Aspect Ratio* option when checked will ensure your image is resized proportionately when only one measurement is being altered but you wish to maintain the image's proportions. For example, if we take our original leaf example that started at 1 inch height by 2 inches width and adjust the width to 1 inch, you can see the following results:

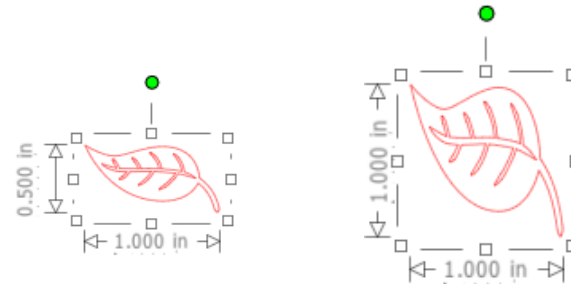

With Lock Aspect Ratio

Without Lock Aspect Ratio

Grid

To assist with viewing measurements, you may also opt to turn on the grid by either right-clicking on your workspace while there are no images selected and clicking on *Show Grid*, or by going to the *Grid* menu.



In the *Grid* menu you may turn the grid on and off, adjust the grid spacing to any desired measurement, and define the number of divisions in the grid.

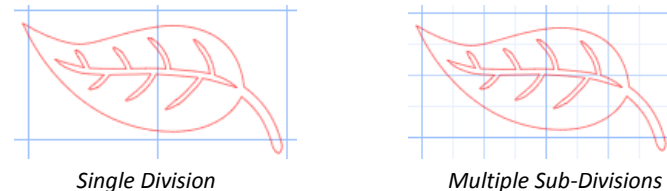

Single Division

Multiple Sub-Divisions

The *Snap to Grid* option when enabled will force the image to conform to grid's measurement and divisions. This may be especially helpful when drawing images to force them to conform to specific desired measurements.

The grid's *Style* may be selected to be either a traditional *Square* grid or an *Isometric* grid. Again, the different styles may be helpful while drawing images within the software to provide a reference for measurement as you draw.

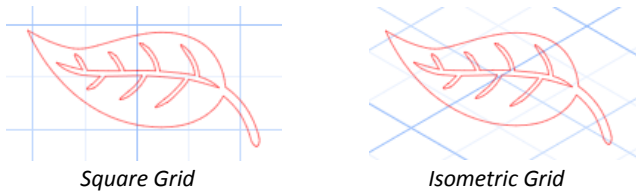

The grid's *Color* can also be adjusted as desired and offers a pre-selected set of color suggestions which may provide a non-intrusive appearance for your grid, though any custom color may of course be selected.

6.7 Mirroring

Some materials or situations require images to be cut in a mirror image format, or you may simply want to flip objects around to achieve your desired image appearance.

To mirror an image, you may right-click any selected image to select the *Mirror Horizontally* or *Mirror Vertically* option.



No Mirror Effect

Mirrored Horizontally



Mirrored Vertically

Mirrored Horizontally & Vertically

Further mirroring options may be accessed in the *Object* menu under the *Transform* sub-menu listed as *Mirror Options*.

In this menu, you may likewise flip your images around (as displayed above) under the listed *Flip* menu options.

You may additionally create mirror copies of selected images with the *Mirror* menu options, where you may create a mirrored copy to the left, to the right, mirrored above, or mirrored below.

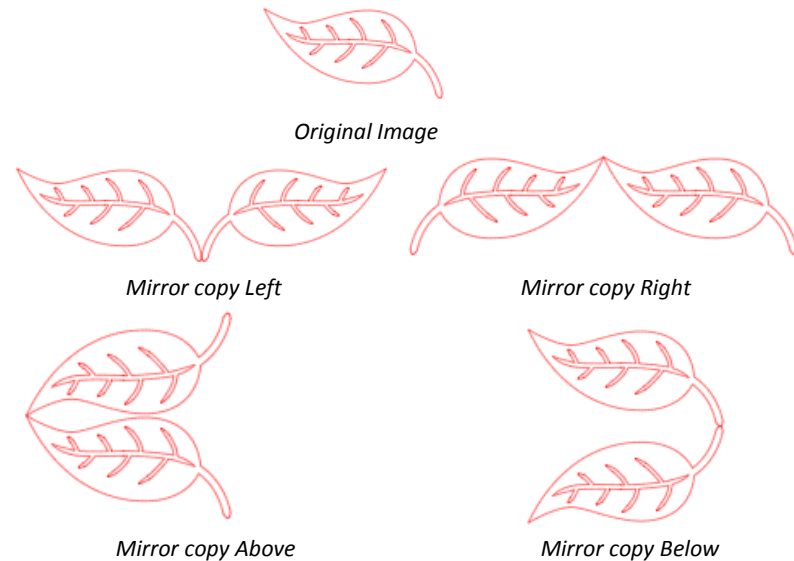

6.8 Arranging

Multiple images may overlap each other. The order of which image is in front and which is in back can be arranged. This is mostly used with filled images for Print & Cut applications so you can determine which image should be in front of the other.

Bring to Front



This option will take your selected image and move it in front of all other overlapping images.



Original Image Order

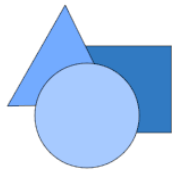

Circle selected and Brought to Front

Send to Back



This option will take your selected image and move it behind all other overlapping images.



Original Image Order

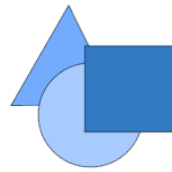

Triangle selected and Sent to Back

In addition to these options, you may also right-click on an image and select *Send Backward* to send the selected image one level back rather than all the way to the back.

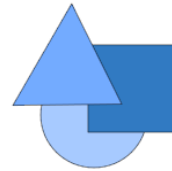

Original Image Order



Triangle selected and Sent Backward

Similarly you may right-click on an image and select *Bring Forward* to bring the selected image one level forward rather than all the way to the front.

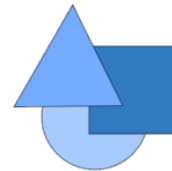

Original Image Order

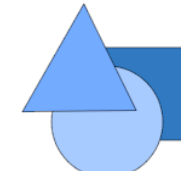

Circle selected and Brought Forward

6.9 Aligning

Multiple images may be aligned in relation to each other. To align images, select two or more images and access the align options by going to the *Object* menu and selecting the *Align* sub-menu. While all options are represented in this *Align* menu, you may also access the *Align* options menu to view a menu with icons instead.

Centralize (*Align Center-Middle*)



This option will center two or more selected objects so that they are lined up with each other in the middle of each other.

Align Left



This option will align two or more selected objects so that they are aligned together to the left edge of the shared bounding box while maintaining their respective distances in regard to being above or below each other.

Align Center



This option will align two or more selected objects so that their center points are aligned together while maintaining their respective distances in regard to being above or below each other.

Align Right



This option will align two or more selected objects so that they are aligned together to the right edge of the shared bounding box while maintaining their respective distances in regard to being above or below each other.

Align Top



This option will align two or more selected objects so that they are aligned together on the top edge of the shared bounding box while maintaining their respective distances in regard to being next to each other.

Align Middle



This option will align two or more selected objects so that their center points are aligned together while maintaining their respective distances in regard to being next to each other.

Align Bottom



This option will align two or more selected objects so that they are aligned together on the bottom edge of the shared bounding box while maintaining their respective distances in regard to being next to each other.

Space Horizontally



When a minimum of *three* objects are selected, this option will take all images and space them horizontally so that all objects are equidistant from each other horizontally.

Space Vertically



When a minimum of *three* objects are selected, this option will take all images and space them vertically so that all objects are equidistant from each other vertically.

6.10 Replicating

Replicating while similar to copying and pasting an image or duplicating it allows for the ability to create any number of copies and place them at once without the need to copy and paste the images multiple times and then have to place them manually around the screen as desired. These options will also create copies next to each other as closely as possible to maximize your cutting area.

To replicate images, select an image and access the replicating options by going to the *Object* menu and selecting the *Replicate* sub-menu. While some common options are represented in this *Replicate* menu, you may also access the *Replicate* options menu to view a comprehensive menu of all available options for this feature.

You will find the following options in the *Replicate* options basic menu.

Duplicate Left



This option will duplicate the selected object and place a copy directly to the left with the most minimal amount of space between the objects as possible.

Duplicate Right



This option will duplicate the selected object and place a copy directly to the right with the most minimal amount of space between the objects as possible.

Duplicate Above



This option will duplicate the selected object and place a copy directly above with the most minimal amount of space between the objects as possible.

Duplicate Below



This option will duplicate the selected object and place a copy directly below with the most minimal amount of space between the objects as possible.

Row of Three / Row of Four



These options will copy the selected object and replicate two or three additional copies next to each other in a row, stacked horizontally next to each other, with the most minimal amount of space between the objects as possible.

Column of Three / Column of Four



These options will copy the selected object and replicate two or three additional copies next to each other in a column, stacked vertically on top of each other, with the most minimal amount of space between the objects as possible.

Rotate One Copy / Two Copies / Three Copies / Five Copies



These options will copy the selected object and replicate one through five rotated copies on top of the original image.

In the *Replicate* menu, you may also access an *Advanced Options* menu. Here you will have the option to select any desired number of copies to replicate your selected image and the distance between these replicated images, including the ability to select any custom direction. Once the desired number of copies and direction has been selected, you may click on the *Replicate* button at the bottom of the *Advanced Options* menu to apply the selected attributes.

6.11 Welding & Modify Options

Overlapping images may be altered in a variety of ways. The *Modify* menu options provide welding and other advanced options to allow overlapping images to be adjusted.



Within the *Modify* menu you may select any of the following abilities.

Weld



While the *Weld* option may be found in the *Modify* menu, there is also a quick access button located along the bottom tool panel of the software screen. Welding will take two or more selected overlapping images and join them together into one single continuous image.



Non-welded image with overlapping lines



Welded image with overlapping lines removed

Welding can be particularly useful when cutting so that the cut lines don't overlap during the cutting process.

Intersect



This option will leave only the overlapping part, or intersecting part, of the selected images when applied.



Original Images



With Intersect Applied

Subtract



This option will remove all overlapping parts of images that are in front of other images, so that only the image located in back will remain with the overlapping parts removed.



Original Images



With Subtract Applied

Crop



This option will remove all areas that are not shared by at least two shapes when overlapping.



Original Images



With Crop Applied

Subtract All



This option will remove any portion of an image that is in back behind another image.



Original Images



With Subtract All Applied

Divide



This option will create individual images from the intersections of up to eight selected images.



Original Images



With Divide Applied

Detach Lines



When images are filled or have thick lines defined, this option may be used to detach and move the outline to create two separate images; one with just the lines and one with just the filled effects left behind.

Compound Paths (*Make / Release*)



These options are the same options previously discussed in the section 6.3 regarding *Compound Paths*. This tool will take overlapping embedded images and either *Make* them into a compound path or *Release* the compound path.

6.12 Offset Options

The *Offset* option may be used to create matted effects for any image.



To apply offset conditions, you will first need to select an image.

Silhouette

Original Starting Image

Within the *Offset* menu you may start by selecting the offset action:



You may select to either have your offset image have a sharper *Corner* appearance, or have a softer more bubbly *Round* appearance.

Though clicking the offset action button provides a starting point, you may fine tune the offset effect to any specified *Offset Distance* with the slider bar, or by typing in a specific measurement.

At any point your desired effect is achieved you may set the properties of the newly created image into place by clicking *Apply*.

Silhouette

Offset Image

7. Library and Online Store

Silhouette Studio offers a library feature to keep and categorize all of your downloaded and user-created image for easy reference, as well as an online store to provide new content for users to download.

The library and store views may be found on the left-hand side of software screen and show which panel (workspace, library, or store) is the current selected active panel.



7.1 Library



The library is where all of your pre-loaded and purchased content is contained and may be categorized, sorted, and accessed.

Viewing

You will be able to either view your images as icons by clicking on the *Icon View* option:

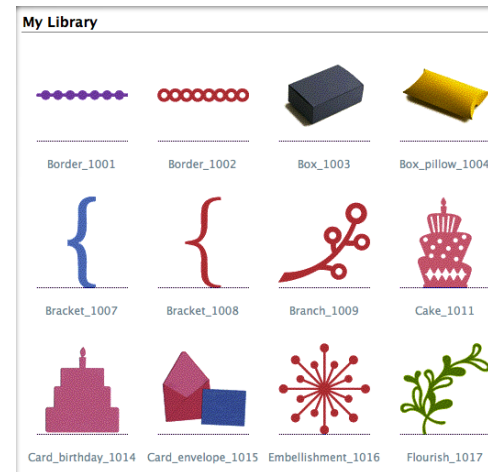

Library in Icon View mode

You may alternately view your library images in a list view to see more detail by clicking on the *List View* option:



My Library					
	Name	Category	Artist	Date Downloaded	Size
	Border_1001	Regular Cut	Silhouette	12:22 PM Aug 14, 2010	0 bytes
	Border_1002	Regular Cut	Silhouette	12:22 PM Aug 14, 2010	0 bytes
	Box_1003	Regular Cut	Silhouette	12:22 PM Aug 14, 2010	0 bytes
	Box_pillow_1004	Regular Cut	Silhouette	12:22 PM Aug 14, 2010	0 bytes
	Bracket_1005	Regular Cut	Silhouette	12:22 PM Aug 14, 2010	0 bytes
	Bracket_1006	Regular Cut	Silhouette	12:22 PM Aug 14, 2010	0 bytes
	Bracket_1007	Regular Cut	Silhouette	12:22 PM Aug 14, 2010	0 bytes
	Bracket_1008	Regular Cut	Silhouette	12:22 PM Aug 14, 2010	0 bytes
	Branch_1009	Regular Cut	Silhouette	12:22 PM Aug 14, 2010	0 bytes

Library in List View mode

In *List View* mode you may sort your images by *Name*, *Category*, *Artist*, *Date Downloaded*, or *Size* by clicking on these column header titles.

In addition to how you view your library content, you also have the ability to adjust how your library is viewed as to whether you are viewing the library only or if you are viewing the library and your workspace. You will find these viewing options on the left-hand side of the software under library and online store buttons.



The top icon showing only one panel will display only your library or online store as they are accessed:

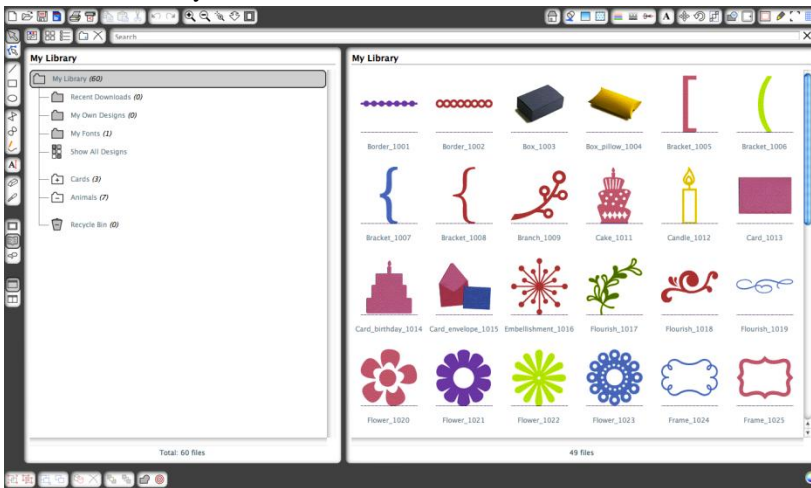

While the bottom icon showing two panels will display your library or online store along side your workspace:

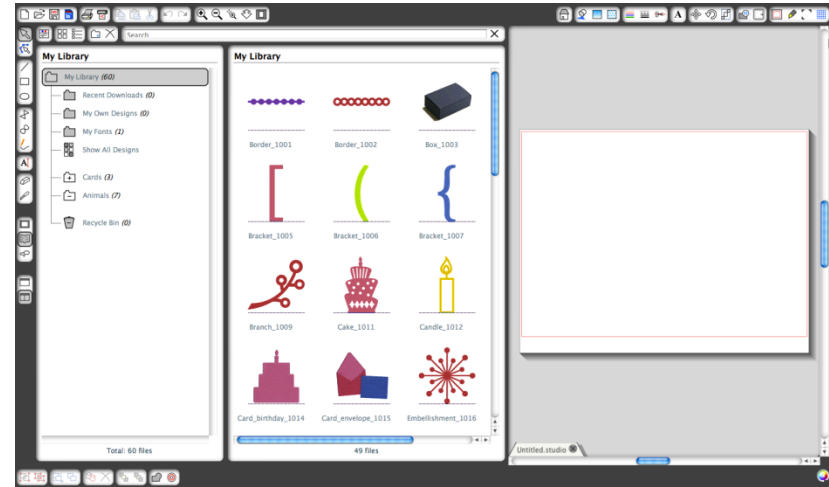

Accessing Library Content

To access library images, you may:

- Double-click on your image to open it onto your workspace
- Drag images from your library onto your workspace (*only if your workspace is being displayed*)

Categorizing & Library Management

As your library continues to grow with additional content, you may find it convenient to customize your library with new folders and sort images according to your liking.

You may add new custom folders by clicking on the *Add Folder* icon.



As new *Untitled Folders* are created, you may immediately name your folder to the desired name. Once your new folder has been created, you may drag and drop images into the folder. Right-clicking on a folder will allow you to create a new sub-folder for that selected folder, delete the folder (along with all contained content), or rename the folder.

In addition to customizing folders, you may also adjust any of your images within the library. Right-clicking on an image will allow you to delete the image, re-name the image, sort the images in the current folder, or show/hide the images properties. Image properties will provide you with the image's description (as downloaded from the online store) and display any associated keywords.

As images or folders are deleted, they will be moved into the library's *Recycle Bin*. You may still restore any of these images or folders by dragging them back into your library. However, once you have deleted any content from your *Recycle Bin*, this content will be permanently deleted from your computer.

7.2 Online Store



The Silhouette Online Store provides additional downloadable content from not only Silhouette America, but also a variety of independent artists and contributing companies. The Silhouette Online store can only be accessed from within the Silhouette Studio software and requires an Internet connection.

The Silhouette's "Purchase Online" shopping section is accessible at any time, 24 hours a day, 7 days a week.

While images may be purchased individually to customize your library experience, subscription options are also available for a monthly fee.

Further information on subscriptions may be found in the *Silhouette Online Store*.

All images are provided with the following benefits:

- You may download images using any major credit card, through download cards, or by using subscription credits
- Indefinite usage (*you do not have to be connected to the Internet to access once purchased*)
- Recoverable (*in case of computer crash or replacement*)
- Resizable and customizable to your specifications (*using Silhouette Studio tools discussed in previous sections*)

Download Cards

Silhouette America offers download cards which provide download credit valid toward any of the store's download content you may wish to purchase and add to your library. You will find two codes on the back of each card. In the lower right-hand corner is the card's identification number. Behind the silver security strip is the actual download code. It is a 16-digit code.

Logging into the Store

Upon accessing the Silhouette Online store by clicking on the *Silhouette Online Store* button, you will be brought to the store's homepage.



You may sign in, or sign up for an account if you do not already have one created, by clicking on the link in the upper right-hand corner noting that “You are not signed in”.

To create an account, you will need to provide your name, your email address (which will be your log-in name), and any desired password.

My Account Options

Once logged into your account, you will find a link in the upper right-hand corner called *My Account* which will provide you with tools to manage your account. You will have the following options:

- **Change My Account Information** – This will allow you to alter your email and password.
- **My Download History** – This will allow you to view a copy of all orders placed. When viewing specific orders, you may also opt to recover a specific order if there was any break in connection during the download process.
- **Recover All Downloaded Designs** – This will allow you to recover any and all previously downloaded content if you are seeking to load the software onto a new computer in the case your computer has crashed or you are simply replacing your computer.
- **Add a Download Card to My Balance** – This is where you may enter any download card codes to apply the available balance onto your account.
- **Manage My Credit Cards** – Allows you to manage any credit card information on file used to pay for subscriptions or individual purchases.

Shopping

You are free to browse all available Silhouette images without any obligation to purchase. You will find a navigation aide on the left-hand side of your shopping window. As categories are selected or as you search for images, you will also find related suggestions listed.

For specific images you are looking for, you may search for specific image names or terms in the upper right-hand corner:

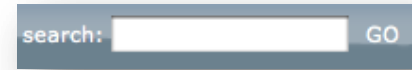

As you browse through the different themes and releases or make specific searches, once you find an image you would like to download, you may either add it to your cart by clicking on the *add to cart* option:



Or you may click on the shape for additional details and listing of similar or related shapes you may be interested in as well.

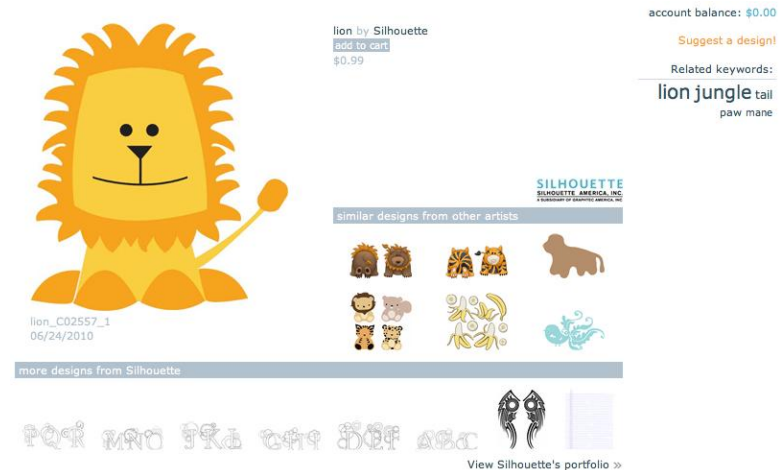

Shapes that have already been added will no longer show the *add to cart* option, but will rather reflect that they are in your cart. Also note that the most recent image added to your cart will show up in your *mini cart* in the lower left-hand corner of the shopping window that will provide a quick access guide to which images are in your cart, how many images have been added, and what your running cart total will be.

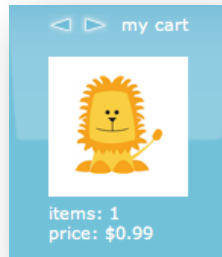

Note that images that have already been purchased cannot be added to your cart and will show that you *already own it*.

Downloading

You may continue to browse and add additional images until you are ready to check out. Once you are ready, you may either click on the *my cart* link in your *mini cart* preview, or click on the *cart* icon in the upper right-hand corner of the shopping window.



When you are ready to download, simply click the *Checkout* button. If you have a balance on your account from a download card or subscription credit, the total charges will be taken from your balance automatically. If you do not have a balance or your account balance does not cover the total of the images you are seeking to purchase, you will be prompted to either provide credit card information or add a download card code to your account.

Once ready, you will be prompted for your password to authorize your purchase. Upon entering your password to confirm the purchase, the library will appear in a panel above the store and you will be able to view your images as they are downloaded into your library.

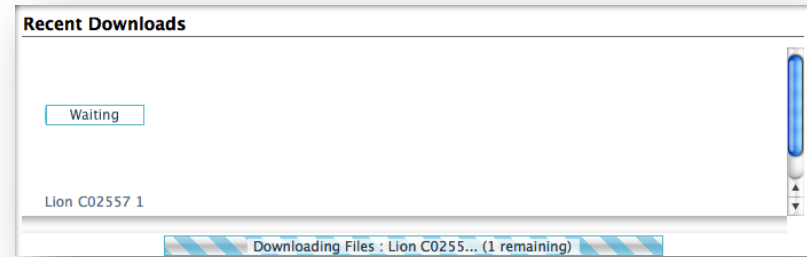

Library screen shot during download



Library screen shot on completion of download

You may then continue to navigate through the online store, or close it as desired. Once your images are all downloaded, you may then drag them from the recent download section and sort them as desired into any of your library folders. Downloaded images will remain in this *Recent Downloads* folder until sorted.

You will note that while all purchased images are stored in your library, purchased fonts will be immediately loaded into the Text Style menu as newly available text options. A list of fonts will be maintained in your library for your reference only. All fonts are still accessed through the Text tools previously discussed in section 5.

Recovering Images

Silhouette America maintains a database of all Silhouette users and their download histories. In the event of a computer crash or computer replacement, after re-loading the software onto your new computer, you may log into your Silhouette user account with your email address and password. Once logged into your account, you may go to the *my account* options to select *Recover All Download Designs*.

If you have multiple computers you own (such as a desktop and a laptop) and are simply seeking to recover your most recently purchased images to a secondary computer, rather than using the *Recover All* option, you may visit your *My Download History* in your account options to access a list of your previous purchases. In this section, you may click on any previous order number and recover your order. Again, you may only perform individual order recoveries to a limited number of computers which you expressly own.

Using the recovery features will not, of course, recover any user-created designs you may have created. Only downloaded images purchased through the shopping section may be recovered. You may back-up your user-created designs by simply locating where you have saved your user-created files and saving them onto a disc or other storage device.

Silhouette America does regulate the number of unique computers you log into and reserves the right to suspend or remove accounts of registered Silhouette users whose account activity may be suspicious or indicative of public file sharing.

8. Saving

After you have created an image or document layout, you will have a variety of options to save your images.

Save



The *Save* option is the basic saving function to allow you to create a **STUDIO** file and save to any location on your computer. These files may be backed up on any removable memory device.

Save As

This option found in the *File* menu will allow you to name your image as it is saved. It is saved to any specified location on your computer and can be backed up to a removable or external memory device as desired.

Save Selection

This option found in the *File* menu will save a **STUDIO** file of only the actively selected images from your document. It is saved to any specified location on your computer and can be backed up to a removable or external memory device as desired.

Save to Library

This option found in the *File* menu will save your file into the *Library* in Silhouette Studio. Upon selecting this option, you will be prompted to enter the name, keywords (which will become searchable upon re-indexing the library, as found under the *Advanced Preferences*), a description, the artist, and the shape's category type. Upon saving images to your library, they will be added to a section labeled *My Own Designs* in the *Library*. These images cannot be navigated to on your computer for manually backing them up, so it is highly recommended to also save a copy of any images using the regular *Save* option.

Save to SD



The *Save to SD* feature will format images to a **GST** file type that can be read directly by the Silhouette SD unit. This feature is only compatible with the Silhouette SD. Such files when formatted in this manner can only be read by the Silhouette SD's slot reader. They are not intended to be opened by Silhouette Studio or any other software once saved.

In order for the Silhouette SD machine to read **GST** files, all files need to be saved in a folder on the SD card's main directly labeled "SD". If a folder called "SD" does not exist, you may simply create a new folder and name it "SD", and then move or save all **GST** files into this folder.

Import to Library

This option differs from the Save to Library option in that this option will allow you to browse to an image on your computer to import it into your library, rather than saving an image you have created from within the software.

Import Portfolio CD

This option is used to import content from *Portfolio CDs* or other special CD offerings from Silhouette America. To import CD content from these offerings, load your CD into your computer's disc drive and cancel any auto-run or installation feature called up by the CD. You may then navigate to this option found in the *File* menu.

9. Cutting/Sketching

Once you have all desired images and/or text on your workspace ready to cut or sketch, you may select the *Send to Silhouette* option.



In this screen, depending on your document size and type of material (also referred to as media type) you are cutting, you will be provided a step-by-step guide as to placing your material into the Silhouette to cut, and how it should be placed onto the carrier sheet (also referred to as the cutting mat), if the intended material type requires the use of the carrier sheet.

9.1 Cut Settings

You will also be provided with the current *Cut Settings*. This will relay to the Silhouette what type of material you are seeking to cut or if you are seeking to sketch with a Silhouette Sketch Pen. You may adjust these settings by selecting the *Change Settings* option in this screen, or at any time in Silhouette Studio by the clicking on the *Silhouette Cut Settings* button.



In this screen, you will be provided with a list of common materials that can be cut with the Silhouette as well as all specialty materials offered from Silhouette America. You may add *User Defined* media types into this list by clicking on the plus sign in the media list, and likewise remove any unwanted material types by clicking on the minus sign.

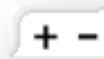

Though settings for common media types and specialty materials are defined for you, you may adjust the following cutting options:

- **Speed** – The *Speed* is measured in centimeters per second x 10. In other words, the Silhouette can cut from 10 centimeters per second up to 100 centimeters per second. To achieve the best results, slower speeds may be recommended for thicker materials or designs that are more intricate.
- **Thickness** – The *Thickness* is measured in approximately 7 grams force per setting and has 33 levels. In other words, the Silhouette can cut from 7 grams up to 230 grams force. Thicker materials will likely require higher *Thickness* levels.
- **Blade Cap Recommendation** – Though the software and actual Silhouette unit will not know what cap you are actually using, the cap recommendation will provide you with a visual cue on what color blade adjustment cap should be used for the intended media. The blue cap exposes 0.1 mm of blade and is generally recommended for thinner papers and films. The yellow cap exposes 0.2 mm of blade and is generally used for regular printer paper and thinner cardstock materials. The pink cap exposes 0.3 mm of blade, the most amount of blade exposure possible, and is intended for thicker cardstock (up to 80 lb weight) and other thicker materials. The *Sketch Pen* refers to Silhouette Sketch Pens that fit directly into the Silhouette unit where the blade would usually be loaded and is intended to be used when sketching rather than cutting.
- **Carrier Sheet** – This check box notifies the program as to whether or not you are using the Silhouette’s carrier sheet (sticky cutting mat). This option may only be selected for material sizes that do not exceed the ability to load materials onto the carrier sheet. Many specialty material types offered by Silhouette America will have their own backing and so do not require the use of the carrier sheet. However, if your material is either too narrow to be gripped by the rollers or does not have its own adhesive backing, you must check this option.
- **Track Enhancing** – This check box notifies the program that you wish to enable the *Track Enhancing* feature, which will roll your material into the Silhouette and back out several times prior to

cutting in order to create a track where the rollers are gripping the material in order to ensure the material stays on track during the cutting process. This option should only be used if it is already pre-selected for your material type or if you are having issues with a specific material type slipping during cutting and causing the resulting cuts to be misaligned.

- **Double Cut** – This check box will have the Silhouette cut through all lines present in your cutting area twice. It may be necessary when cutting thicker materials in order to obtain a cleaner cut.

9.2 Performing a Test Cut

When going to cut a new material type you have not previously cut, whether it be a pre-defined media-type setting or a new User Defined media type you are trying to find the correct settings for, it is advisable to perform a *Test Cut* in order to ensure your settings are correct and you will be able to obtain a clean quality cut for your intended job.

To perform a *Test Cut*, click on the Blade Position Arrows to move your blade so that it is resting over your loaded material in the Silhouette unit.



Once your blade is in position where you wish to make a small cut, you may click on the *Test Cut* button. The Silhouette will then cut a small square with an imbedded triangle so that you may gauge your results and determine if any settings need to be adjusted. You may continue to make further test cuts until results are to your satisfaction.

9.3 Cutting / Sketching

Once you have selected the correct settings and are ready to send the active workspace to the Silhouette, you will want to ensure your material has been

loaded properly and that you have selected the correct blade cap for cutting, or that you have loaded a pen in the case you are sketching.

Blade Preparation

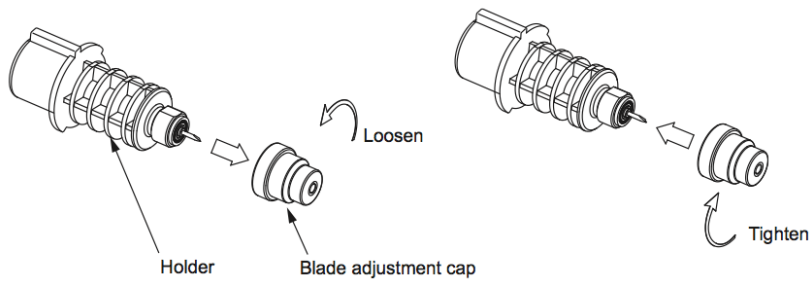

You will first want to change the blade cap to the suggested cap as recommended in the software program or according to your testing results.

Once the correct cap is on your blade, you may unlock the blade holder's locking lever on the Silhouette as shown below.

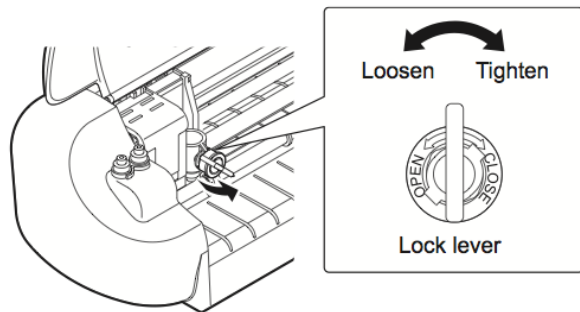

Once the locking lever is open, drop the blade into the Silhouette's blade holder and then tighten the lever to lock the blade into place by turning the lock lever to the right.

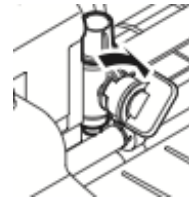

Silhouette Sketch Pens may be dropped and locked into place in this same manner. The program will work in the exact same way for cutting or sketching. The only difference will be whether you load the blade or a pen.

Carrier Sheet Preparation

When using a material that is not wide enough to be gripped by the Silhouette's rollers or that does not have its own adhesive-backing, you will need to use a carrier sheet and load as displayed below.

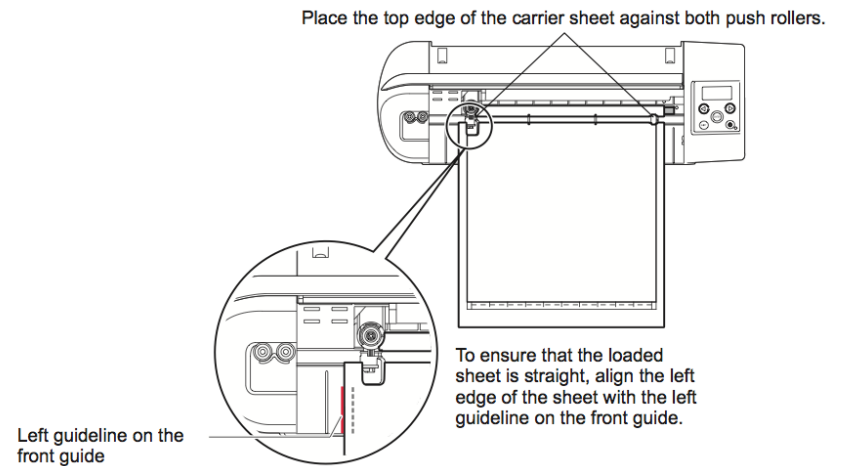

Performing the Cut

Once everything is set up and you have the correct *Silhouette Cut Settings*, you may return to the Send to Silhouette Screen by clicking again on the *Send to Silhouette* option.

From this screen, once ready, you will simply click on the *Cut page* command. The Silhouette will then proceed to cut or sketch your job as you have created.

Upon completion, you may unload your carrier sheet and/or material by manually rolling the feed knob (original Silhouette) or by pressing the *Enter* key on the Silhouette (Silhouette SD).

10. Print & Cut

The Silhouette and Silhouette SD have the special ability to read printed jobs sent from Silhouette Studio in order to cut the contour lines defined in your workspace as they outline print information. In other words, you are able to print an image with filled color or effects to your regular home printer and then feed the printed sheet into the Silhouette to cut out around the printed image.

10.1 Registration Marks

The Silhouette and Silhouette SD have an optic scanner for reading marks that can be printed by Silhouette Studio. These marks are called *Registration Marks*. These marks will print around the border of your workspace and will be read by the Silhouette's optic scanner prior to cutting so that the Silhouette can triangulate according to where these marks are located and know exactly where the cut lines are defined around your printed images. Registration marks are only used when printing images for the purpose of performing *Print & Cut* jobs.

To access these marks, click on the *Registration Marks* icon.



You may enable the registration marks by clicking on the *Show Reg Marks* check box. If desired according to the job being performed, these marks can be adjusted. Please note that while you may make the marks smaller, if the Silhouette fails to locate these marks, you may need to adjust the registration mark size to ensure the optic scanner is able to successfully locate these marks.

You will note that the marks have a hash mark fill around them.

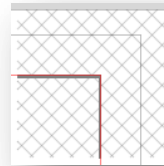

This hash mark fill indicates that print information cannot be contained in this area in order for the optic scanner to operate properly.

10.2 Cutting Printed Images

With the registration marks displayed, you are ready to perform *Print & Cut* jobs. Again, this does not mean that the Silhouette will scan and cut around *any* print information. Rather the Silhouette is using the registration marks to know where your cut lines are defined around your printed image. Your image must have lines around your printed image which are defined to be cut (see the *Line Styles* section on page 18).

The following is an example of a Print & Cut job.

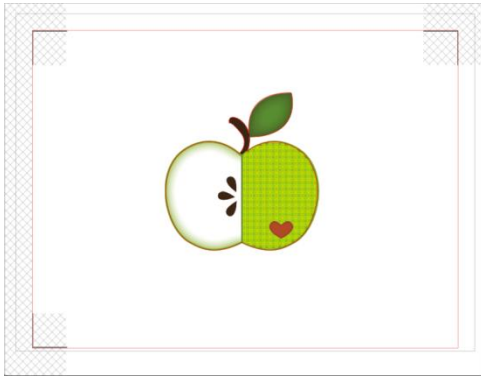

In this case, your printer will see the following to print out:



While the Silhouette will see the following to cut:



When your job is ready, you may print it by accessing the *Print* option.



Once printed, it is important to remember not to make any further adjustments to the document as it appears on your screen. If any objects are moved and the location of printed or cut information is altered, you will need to re-print your document.

To use the Silhouette's *Automatic Registration Mark Reading* feature, set up your job as directed in the previous section. Prior to cutting, you will be asked if you wish to *Detect Registration Marks*. Select this option to proceed on to the automatic detection process. The Silhouette's optic scanner will then locate the marks for you. Once all marks are successfully detected, you may then select to cut, at which point the Silhouette will cut the defined lines around your printed image.

As previously noted, Silhouette Studio allows you to fill any image with fill colors, gradients, and patterns. Though Silhouette America does offer pre-made special Print & Cut images that are designed to only have print information inside and a cut edge around the outside of the image, literally any image can be turned into a Print & Cut image by using the tools provided in Silhouette Studio.

11. Trouble Shooting

If you experience problems, a list of common trouble-shooting tips and further support information may be found below.

11.1 Common Troubleshooting Tips

Blade won't cut through material

If using the original Silhouette, make sure the notch on the blade (*the black "fin" on the base of your blade*) is turned to the right, facing the blue power light in the 3 o'clock position. When the notch is faced in this direction and locked into place, the blade will be lowered slightly and thus deliver more cutting force. Again, this would be for the original Silhouette only.

Regardless of which Silhouette model you have, blade positioning could still be an issue if the blade had been removed recently to change the cap. The blade may not be fully seated in the holder and thus not delivering clean results when cutting. To check this, unlock the blade and while holding the lock lever in place, twist and push the blade down to make sure it is seated all the way down in the holder.

You may also check the *Silhouette Cut Settings*. If you are cutting with a depth that is too shallow or the cap is a thinner cap (blue or yellow), you may need to adjust your cutting settings or blade cap according to the type of paper or media you are trying to cut. Use the *Test Cut* button to ensure your settings are set up correctly for the media type you are using prior to going through the entire cutting process. If the test cut does not work, you most likely need to re-adjust the settings. If the test cut works, the actual cut job should work.

If you find for any reason that there are areas not giving a clean cut, you may also wish to select to use the *Double Cut* option in the *Silhouette Cut Settings* to ensure any problem areas are given an extra pass during the cut job.

Images are not aligned when cut

When cutting regular paper or cardstock that does not have its own adhesive-backing, please ensure you have loaded your paper onto your carrier sheet. This issue may be experienced if you are not using the cutting mat properly or are not using it with materials that would require the use of a carrier sheet.

If you are using the carrier sheet, you will want to ensure the mat's liner has been removed to expose the sticky surface so that your material is being held down in place firmly during the cutting process. If the mat has lost its adhesive quality for any reason and is not holding the paper firmly in place, this may cause your paper to drift as it is being cut.

If you are using the cutting mat and your paper is being loaded onto the cutting mat correctly and held firmly in place, you may be experiencing this issue if you have loaded your carrier sheet or material into the Silhouette lined up with the left-hand side of the machine, as opposed to lining up the carrier sheet or material with the raised guide. If the carrier sheet or material being cut is not lined up correctly with this guide and is not being initially grabbed between the two white rollers, you would experience the issue of your carrier sheet or material drifting as it is being cut and your image would not be aligned properly.

New Hardware Wizard appears each time Silhouette is powered on

If your computer is asking you to install the software (even though it is already installed), this is likely when you are turning on the Silhouette or if you have unplugged the USB and are plugging it back in. Your computer is simply thinking there is a new hardware device it has not yet recognized. You may safely navigate through the automatic recommended installation as it simply is referring to the driver. The driver is contained on your installation CD, or in the case of downloading the software may be obtained from www.silhouetteamerica.com in the *Support* section. The driver is actually not necessary for proper use of the software, but may be used to quiet the Windows Plug & Play feature which tries to find hardware drivers

when new devices are connected. After re-installing the driver, you should no longer receive this prompt to install.

NOTE: You may see a threatening message from Microsoft during driver installation that mentions the driver is a potential risk or has not passed Windows logo testing. Please note that the driver has been tested extensively and will safely work with Windows XP, Windows Vista, and Windows 7. Click on the "Continue Anyway" button and proceed with the driver installation process.

Unload Media is displayed immediately after loading (SD model only)

This is not an error. Once you have selected one of the loading options, whether or not you have actually loaded anything into the machine, the Silhouette will think that material has been loaded and await further action to cut either through your computer or through a SD card. As it is waiting to cut, the initial option displayed will show *Unload Media*. This is displayed in case you had loaded your material incorrectly or if it was not loaded into the machine straight. After the cutting process has ended, you will likewise be shown this option displayed to unload your material.

If there is no material actually loaded yet and the *Enter* key was accidentally pressed, you may simply press the *Unload Media* button and then scroll over to again find the loading options on the Silhouette SD's LCD screen to properly load your material to cut.

Carrier sheet stuck in Silhouette (SD model only)

Turn on the Silhouette SD and press the arrow keys on the LCD screen of your Silhouette until the *Unload Media* option is displayed. Once displayed, press the *Enter* key. If the mat is not fully ejected, please perform these actions again until the mat is fully ejected. You may alternately power off the Silhouette SD and manually pull the mat from the machine.

Silhouette is loud during operation

Please lift the Silhouette's lid to ensure any tape that is connecting the motor to the side of the unit has been removed. If this was not previously removed, this would be the cause of the noises experienced when your

machine was powered on. If the tape had been left on, no damage should have been experienced, but the noises heard would be atypical. Please remove the tape and again power the Silhouette unit back on.

Otherwise, please note that the Silhouette is unfortunately not a whisper quiet unit. The sounds you are hearing are likely normal.

ERROR: Could not connect to the Silhouette

When in the Send to Silhouette screen to send your job to the Silhouette, if this message is displayed, you will need to check your USB connection to ensure it is firmly connected from the computer into the Silhouette. You may wish to power off the Silhouette and then unplug both ends of the USB cord. You may then power the Silhouette back on and plug the USB cord back in to your computer and the Silhouette. If problems persist, close Silhouette Studio and restart your computer.

ERROR: Detection of registration marks failed

When using Registration Marks for Print & Cut jobs, if this message is displayed, remove your media or carrier sheet from the Silhouette and re-load. Most commonly, this error is encountered if the media or carrier sheet was loaded so that it was not aligned properly with the loading guide marks.

11.2 Further Support Contact Information

Further support information may be obtained through the following sources:

Web: www.silhouetteamerica.com

Email: support@silhouetteamerica.com

Phone: 800.859.8243 (*Toll-free U.S. & Canada only*)

Silhouette America, Inc is based out of American Fork, Utah and is open 8am to 5pm (Mountain time).

Training on software usage or techniques is not offered by support staff. Further training and techniques may be located on Silhouette America's website in the *Tutorial* section.

The specifications, etc., in this manual are
subject to change without notice.

September 8, 2010 1st edition
Silhouette America, Inc.

Index

A

About	3
Account Options (Online Store)...	39
Add Media Types (Cut Settings)...	43
Add Points	15
Agreement	3
Aligning.....	31
Animation.....	13
Antialiasing	13
Arranging	30
Available Content	3

B

Blade Cap (Cut Settings).....	43
Blade Preparation.....	44
Break Path	16
Bring Forward	30
Bring to Front	30
Buttons, Size	13

C

Carrier Sheet (Cut Settings)	43
Carrier Sheet (Preparation)	45
Carrier Sheet (Revealing)	10
Centralize (Alignment)	31
Character Spacing (Text)	22
Circle Tool	14
Color Scheme	13
Compound Paths	25
Corner (Point Editing)	16
Crop	34

Curved Shape Tool	14
Cut Settings	43
Cut Style (Cut, Perforate).....	18
Cutting	44
Cutting Area	8
Cutting Printed Images.....	46

D

Delete	24
Delete Point	16
Deselect All	23
Detach Lines	35
Dimensions, Specifying	28
Disclaimer	3
Divide	35
Document Sizes	9
Document Tabs	9
Double Cut (Cut Settings)	43
Download Cards	38
Downloading	40
Drawing Tools	14
Duplicate	23

E

Edit Points	15
Editing Images	15
Eraser Tool	17

F

File Formats	5
--------------------	---

Fill Color	19
Fill Gradient	19
Fill Pattern	20
Fit to Page	12
Fonts, Available	21
Fonts, Characteristics	21
Freehand Tool	14

G

Grid	28
Grouping	25

I

Import Portfolio CD	42
Import to Library	42
Installing	6
Intersect	34

K

Knife Tool	17
------------------	----

L

Language	13
Library	36
Library, Accessing Content	38
Library, Folders	38
Line Color	17
Line Style (Thickness)	18
Line Tool (Drawing)	14
Logging in (Online Store)	39

M

Make Compound Path	26
Make Curve (Line Editing)	16
Make Flat (Line Editing)	16
Measurement, Units	13
Mirroring	29
Modify Options	33
Moving Images	27

O

Offset	35
Online Store	38
Opening documents	9
Opening the software	7
Orientation, Cutting	11
Overview	4

P

Page Tools	10
Paste	23
Paste in Front	23
Perforate	18
Point Editing Mode	15
Polygon Tool	14
Preferences	12
Print & Cut	45
Print	46
Print Cut Lines	19

R

Recovering Images	41
Rectangle Tool	14
Redo	24
Registration Mark Reading	46
Registration Marks	45
Re-index Library	13
Release Compound Path	24
Replicating	32
Rotate Copies (Replicating)	33
Rotating	27

S

Save As.....	41
Save Selection.....	42
Save to Library	42
Save to SD	42
Save.....	41
Scale.....	28
Select All.....	23
Select Tool.....	15
Selecting	22
Send Backward	30
Send to Back	30
Send to Silhouette.....	42
Shopping	39
Simplify (Point Editing)	16
Sizing	27
Sketching	44
Smooth (Point Editing)	16
Software Sections.....	7
Spacing Horizontally	32
Spacing Vertically	32

Speed (Cut Settings)	43
Subtract.....	34
Support (Contact Information).....	49
System Requirements.....	4

T

Test Cut	44
Text, Creating	20
Text, Justification	21
Text, Manipulating	21
Text, Size	22
Thickness (Cut Settings)	43
Track Enhancing	43
Trademarks	3
Troubleshooting	47

U

Undo	24
Ungrouping	25

W

Weld	33
------------	----

Z

Zoom In	12
Zoom Out	12
Zoom, Drag	12
Zoom, Selection	12
Zooming	12