

XTOOL | M1 Ultra

User Manual | Benutzerhandbuch | Manual de Usuario | Manuel
d'utilisation | Manuale utente | Manual do Usuário |
Gebruikershandleiding | 取扱説明書 | 사용자 매뉴얼 | 用戶手冊 | 用戶手冊

XTOOL



English	01
Deutsch	25
Español	49
Français	73
Italiano	97
Português	121
Nederlands	145
日本語	169
한국어	193
繁體中文	217
简体中文	241



EN	Video tutorial: support.xtool.com/article/1291	PT	Tutorial em vídeo: support.xtool.com/article/1291
DE	Video-Anleitung: support.xtool.com/article/1291	NL	Video-handleiding: support.xtool.com/article/1291
ES	Tutorial en vídeo: support.xtool.com/article/1291	JA	ビデオ・チュートリアル: support.xtool.com/article/1291
FR	Tutoriel vidéo: support.xtool.com/article/1291	KO	비디오 튜토리얼: support.xtool.com/article/1291
IT	Video tutorial: support.xtool.com/article/1291	ZH-TW	視頻教程: support.xtool.com/article/1291



ZH	视频教程: yuque.com/makeblock-help-center-zh/xgren8/video_tutorial
----	---

EN

Statement	02
Safety first (important)	02
List of items	04
Meet your xTool M1 Ultra	06
Preparations	08
Use xTool M1 Ultra	12
Indicator description	21
Maintenance	22
FAQs	24
Declaration of conformity	24
FCC statement	24
FCC Radiation Exposure Statement	24
After-sales services	24

Statement

Thank you for choosing xTool products!

If you use the product for the first time, read carefully all the accompanying materials of the product to improve your experience with it. If you do not use the product according to the instructions and requirements of the Manual, or mis-operate the product due to misunderstanding, etc., the Company shall bear no responsibility for any loss resulting therefrom.

The Company has collated the content of the Manual rigorously and carefully, but errors or omissions may remain.

The Company is committed to continuously improving product functions and service quality, and therefore reserves the right to change any product or software described in the Manual and the content of the Manual at any time.

The Manual is intended to help you use the product properly and does not include any description of hardware and software configuration. For product configuration, refer to the related contract (if any) and packing list, or consult your distributor. Images in the Manual are for reference only and the actual product may vary.

Protected by copyright laws and regulations, the Manual shall not be reproduced or transcribed in any way, or be transmitted on any wired or wireless network in any manner, or be translated into any language, or be modified in any way, such as content, image, or layout modification, without the prior written authorization of the Company.

The Company is committed to continuously improving the product and related materials. The product and the Manual are subject to change, and updates can be found at xtool.com.

Safety first (important)

1. General safety

Read and get familiar with all safety precautions and procedures before using the machine. Strictly follow all safety precautions. Ensure that the machine is properly assembled.



Follow the operating principles:

- Check the machine for damage every time before you use it. Do not operate it in any way when any damage or defect is found.
- Ensure that the workspace is clean and flat.

- Do not disassemble the machine or change its structure in any way without authorization. Do not modify or decompile its operating system.
- Do not leave the device unattended during operation. Pay attention to whether it is working properly.
- Keep the inside of the machine clean. Residues and chippings accumulated during cutting and engraving are dangerous and may cause a fire. Clean the chippings and residues inside the work area regularly.
- The machine works properly at the temperature of 0°C to +35°C and can be stored properly at the temperature of -10°C to +40°C. Do not operate it at a temperature lower than 0°C.
- This product is not user-serviceable. It must be returned to the factory or repaired by authorized professionals.

2. Laser safety

Generally, the laser module is completely enclosed in the casing and light shield during operation. The device has a safety interlock switch. If the lid is lifted during operation, the device will stop working.



Follow the safety precautions:

- Do not operate the machine when any part of it is removed. Removing any part may expose the laser system and cause damage to the machine.
- Do not engrave or cut any material that contains PVC or vinyl (processing plastics is not recommended). These materials (and other materials containing chlorine/chloride) can generate corrosive vapor that is extremely harmful to the human body and can cause damage to the device. Any damage caused by engraving or cutting any material containing PVC or vinyl is not covered by the Company's warranty.
- Do not engrave or cut any unknown materials. Vaporization or melting of many materials, which include but are not limited to PVC and polycarbonate, may release harmful smoke.
- Laser operation is prohibited when the lid is lifted. Make sure that the lid is closed during operation and do not tamper with the safety mechanism of the lid.
- Do not leave the device unattended during operation. Pay attention to whether it is working properly.

The reference standards for laser safety are the American National Standard for Safe Use of Lasers (Z136.1-2022), International Electrotechnical Commission Standard (IEC 60825-1:2014), and European Standards (EN 60825-1:2014/A11:2021 and EN 50689:2021).

3. Fire safety



A high-density laser beam is used by the device to irradiate the material to be cut or engraved, so as to heat up the material surface and vaporize the material without burning. But most materials are inherently flammable and may be ignited to form an open flame that can burn down the device (even if it is made of flame-retardant materials) and its surroundings. Experience shows that vector cutting with a laser is most likely to produce an open flame. In particular, acrylic has proven to be extremely flammable in vector cutting.



Read the following warnings and suggestions carefully:

- Equipment for use in locations where children are not likely to be present.
- Ensure that the workspace is well-ventilated so that the generated smoke can be discharged in time.
- Do not stack materials (especially organic ones, such as paper) around the machine (especially the end of the smoke exhaust pipe). They may cause the spread of flames and increase the risk of material ignition.
- Do not leave the machine unattended when it is working. If the machine works with setting errors and is left unattended for a long period of time, or if a mechanical or electrical fault occurs, a fire may be caused.
- Clean the device regularly. Excessive accumulation of residues and chippings from cutting and engraving would increase the risk of fire. The internal working area needs to be cleaned periodically to ensure that there is no residue or chipping inside the device.
- Ensure that the area around the machine is clean without any cluttered flammable materials, explosives, or volatile solvents, such as acetone, alcohol, or gasoline.
- Keep a fire extinguisher and perform regular maintenance and inspection of it.
- If a fire occurs during processing, take good care of yourself. For a small flame, you can wait for it to go off; for a larger fire, please keep a safe distance and use a fire extinguisher to put it out.
- It is recommended that you use xTool fire safety set when engraving or cutting the flammable materials with the laser beam to prevent the fire.

4. Electrical safety



Read the following warnings and suggestions carefully:

- Do not open any access panel on the device when the device is connected to the power supply. Accidental contact with the power supply may cause injury.
- Do not touch any electronic area with your hands or other tools when the machine is connected to a power supply.

5. Maintenance



Caution – Use of controls or adjustments or performance of procedures other than those specified herein may result in hazardous radiation exposure.

Read the following warnings and suggestions carefully:

- Cut off the power before maintaining the device.
- Prevent blade contact with your fingers when removing the laser module or blade, or you may get hurt.
- Blades are very sharp. Be careful not to hurt your hands when installing or replacing them.
- Place the used blades in a container that can prevent sharps from hurting people, such as a metal box, seal the container, and dispose of it.

6. Warning and instruction signs

On xTool M1 Ultra, the warning and instruction signs are labeled where physical injuries or damage to the machine may be caused before and/or during operation. If a sign is damaged or lost, replace it immediately. You can use the following template to print the sign you need.

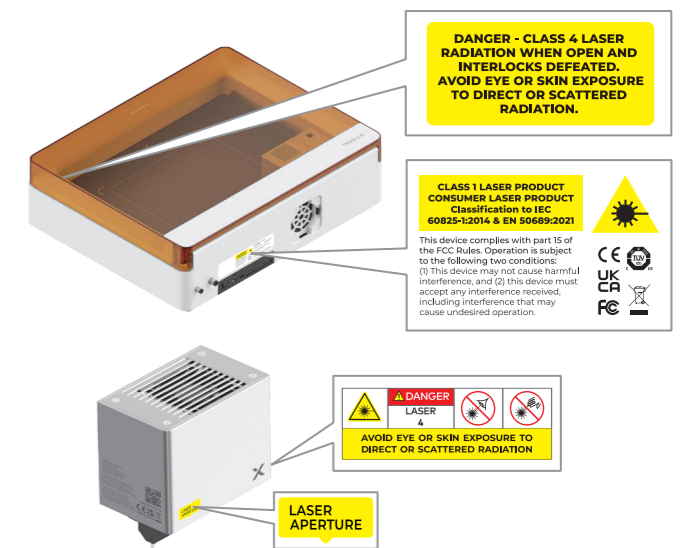

Maximum RF transmit power: Wi-Fi 2.4G (2412-2472 MHz) < 20 dBm

Laser specifications

	Wave-length	Beam divergence	Maximum power output
Working laser	455±5nm	1.5mrad (IEC 60825-1 Default (simplified) evaluation C6=1)	20 W
Indicator laser	650±5nm	/	0.39 mW

List of items

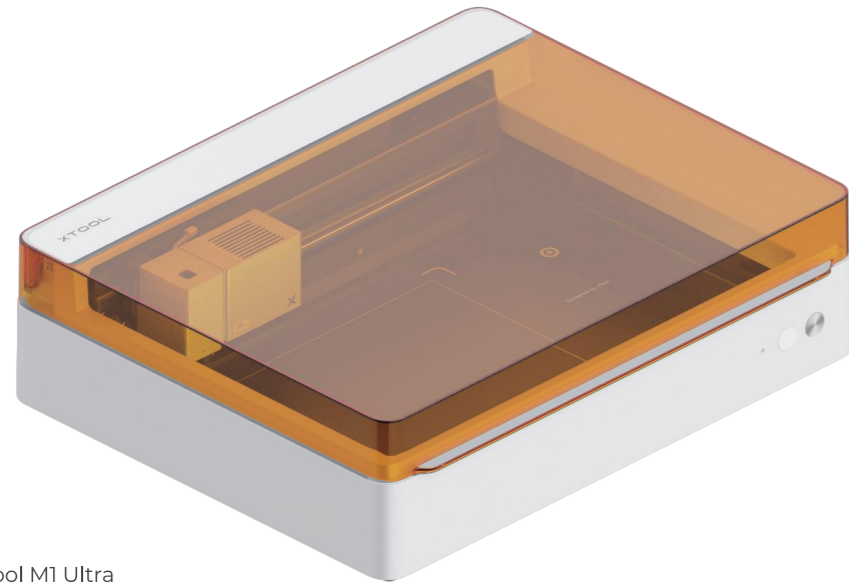

01 xTool M1 Ultra



02 Laser module

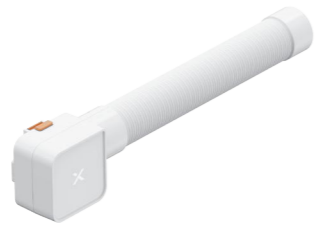

03 Smoke exhaust module



04 USB cable

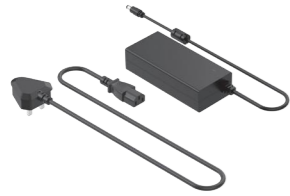

05 Power cable and adapter



06 Fine-point blade



07 Fine-point pen



08 Pen holder

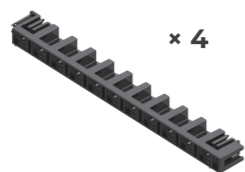

09 Triangular prism holder

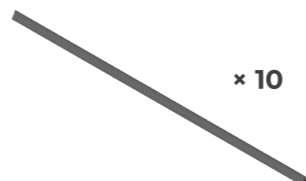

10 Triangular prism

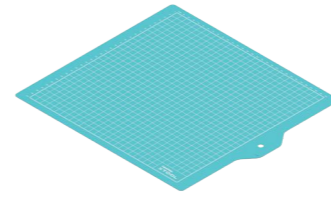

11 Cutting mat (LightGrip)

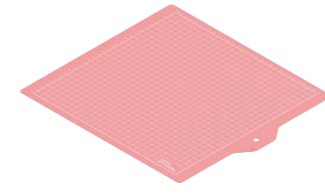

12 Cutting mat (FabricGrip)



13 Filter



14 Key



15 Grease

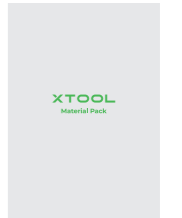

16 Material pack

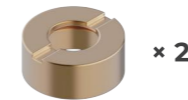

17 Lens mount (spare part)



18 Lens mount rotating piece



19 Screwdriver



20 User manual



21 Multi-function carriage



22 Cutting blade

Meet your xTool M1 Ultra

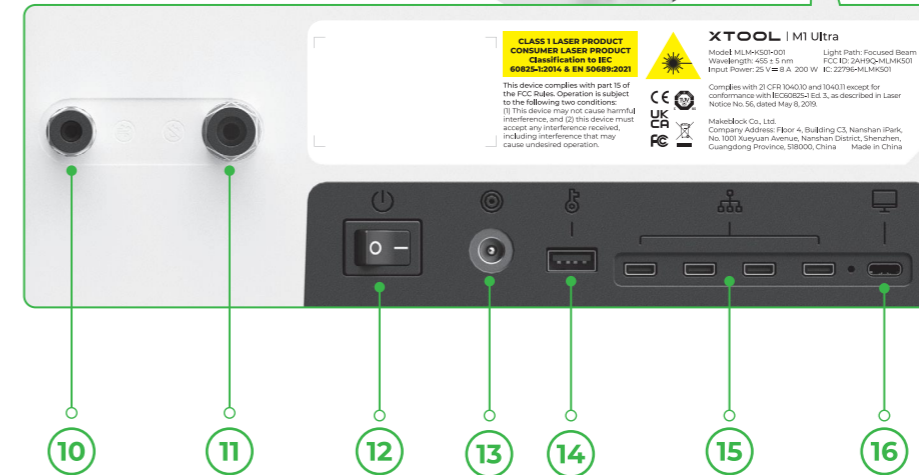
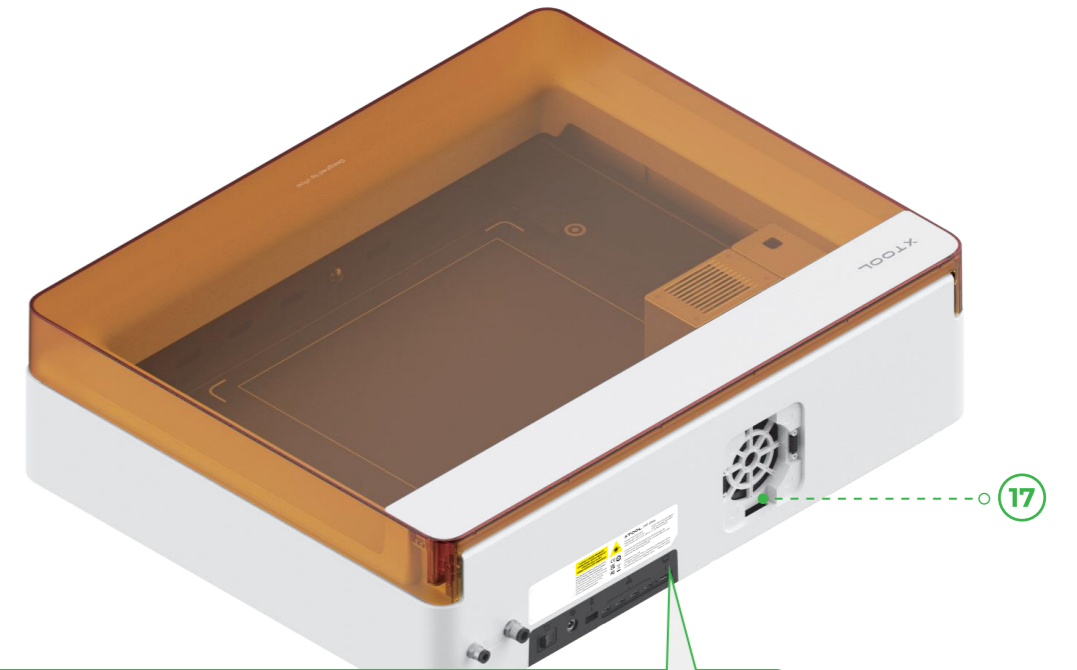
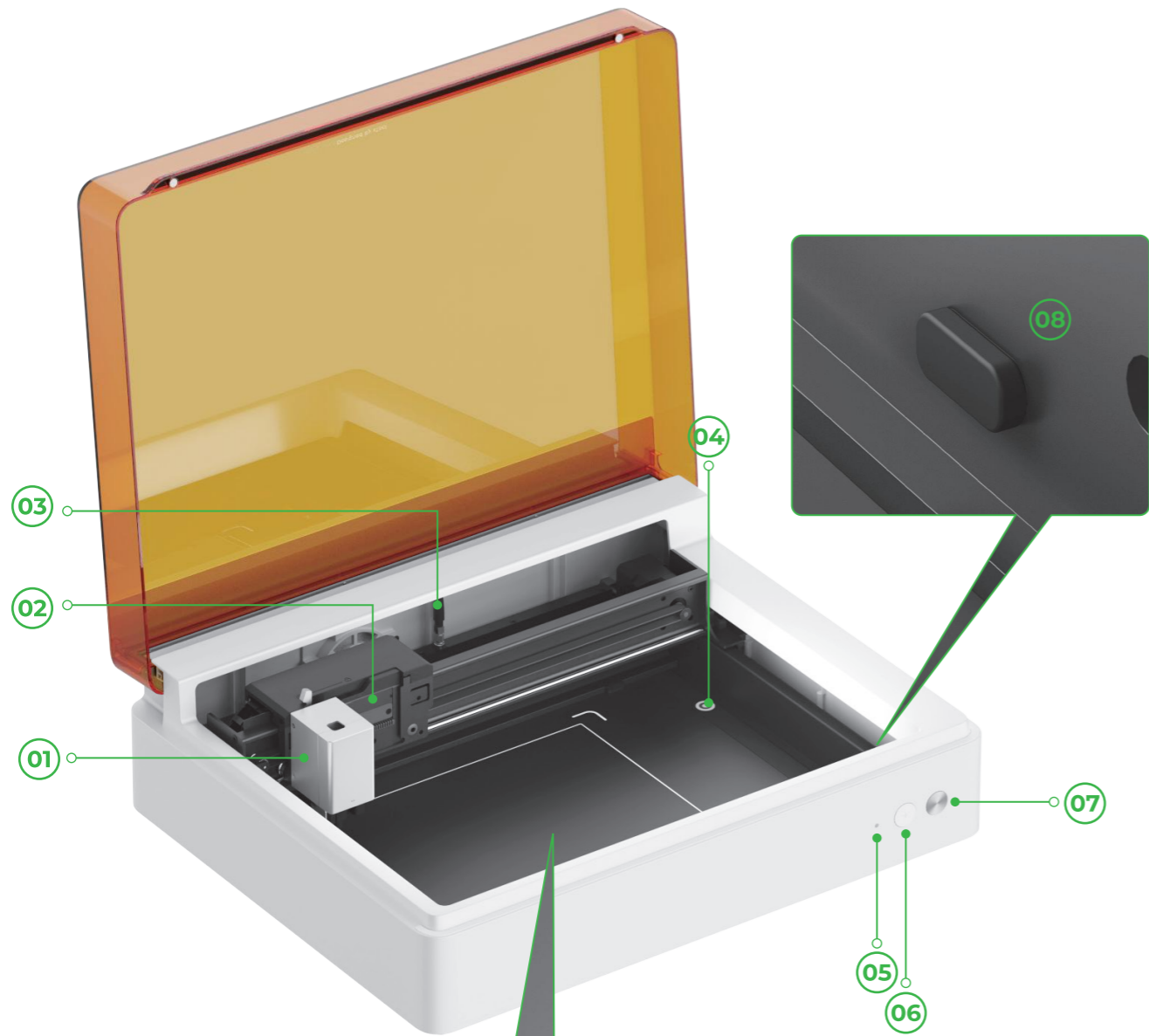

- | | | |
|----------------------------|---|-----------------------|
| 01 Basic carriage | 07 Start/Stop button | 13 Power port |
| 02 Multi-function holder | 08 Rotary Attachment port | 14 Port for the key |
| 03 Wi-Fi antenna | 09 Thumb screw for the baseplate | 15 Extension port × 4 |
| 04 Camera viewfinder point | 10 Tube fitting for the air assist set | 16 USB port |
| 05 Indicator | 11 Tube fitting for the fire safety set | 17 Smoke outlet |
| 06 Point marking button | 12 Power switch | |

Preparations

1

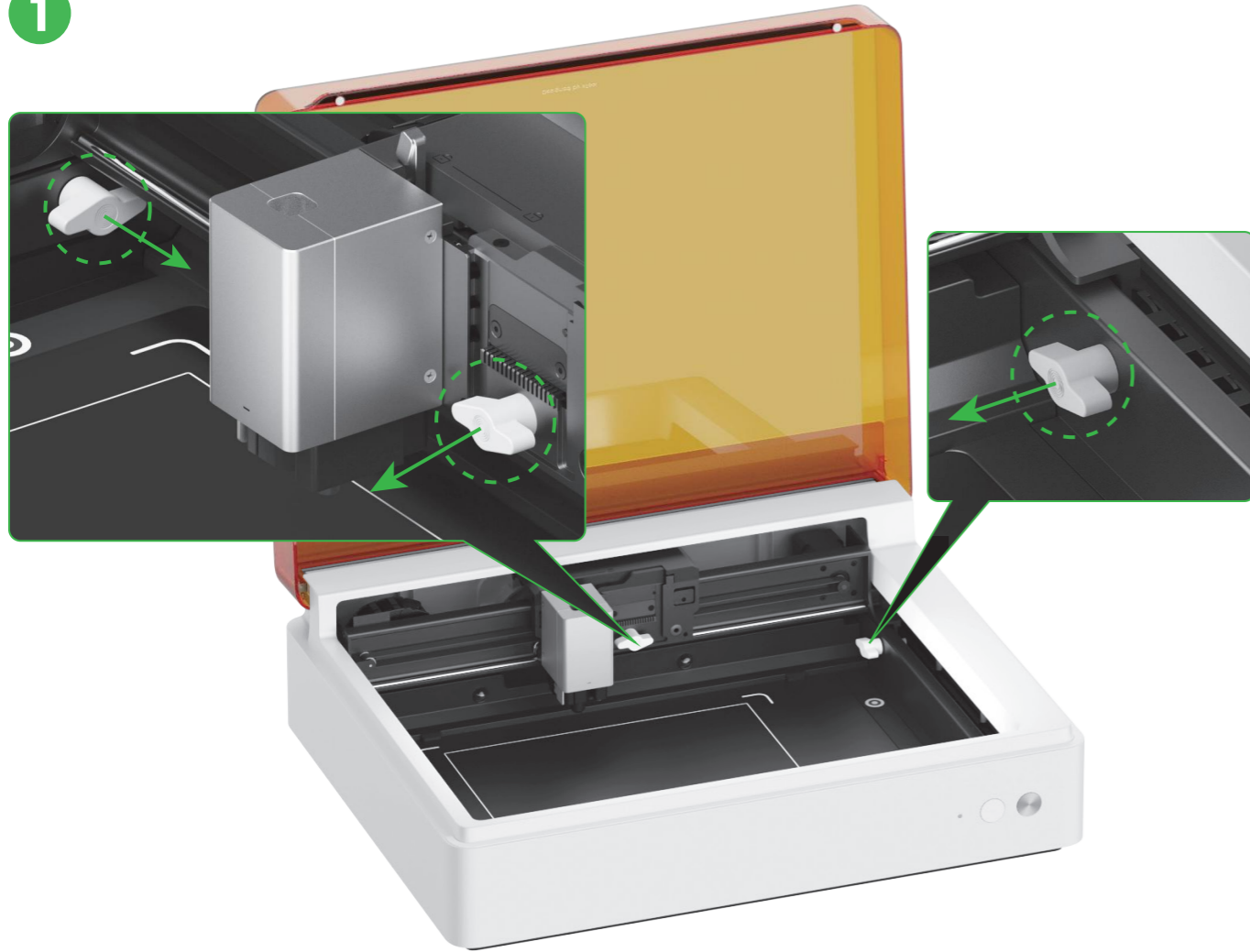

2

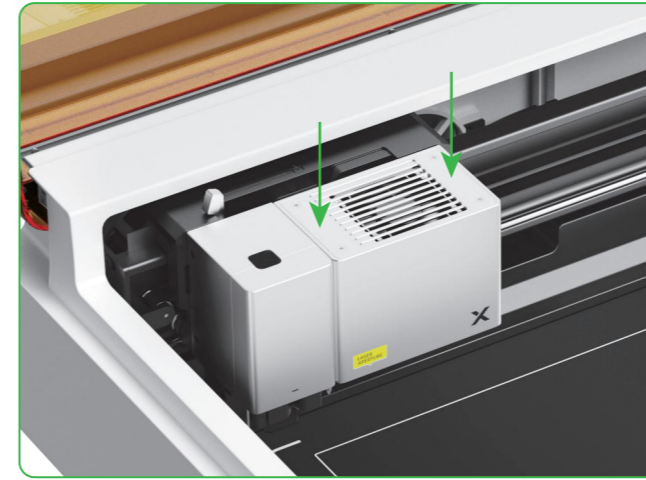
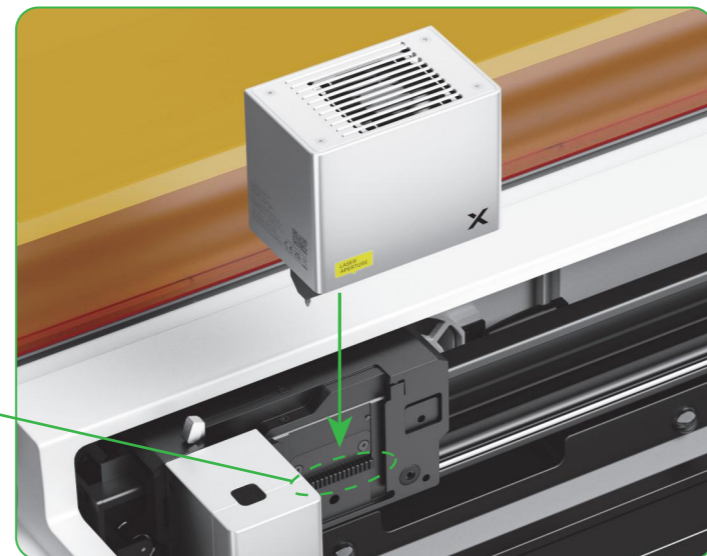

Press the laser module down until you hear a click.



3



Do not use the smoke exhaust module without the filter. Or it may absorb smoke and dust and get damaged.

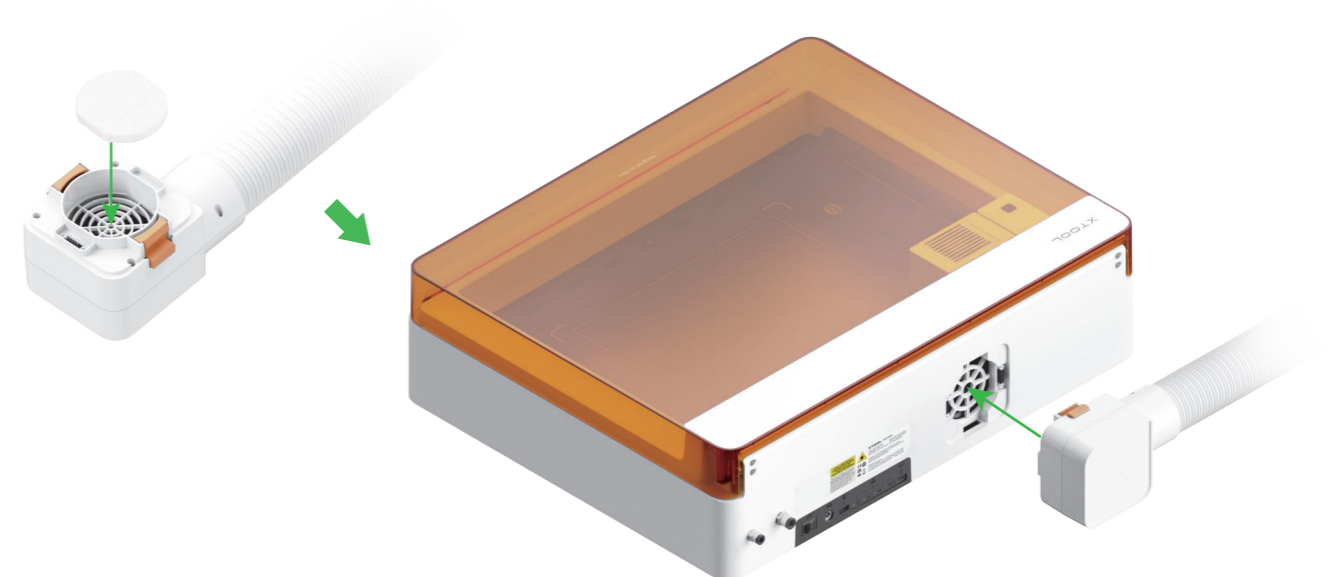

4

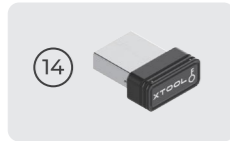

Insert the key to unlock the processing and related functions. You can remove the key to lock the processing and related functions.

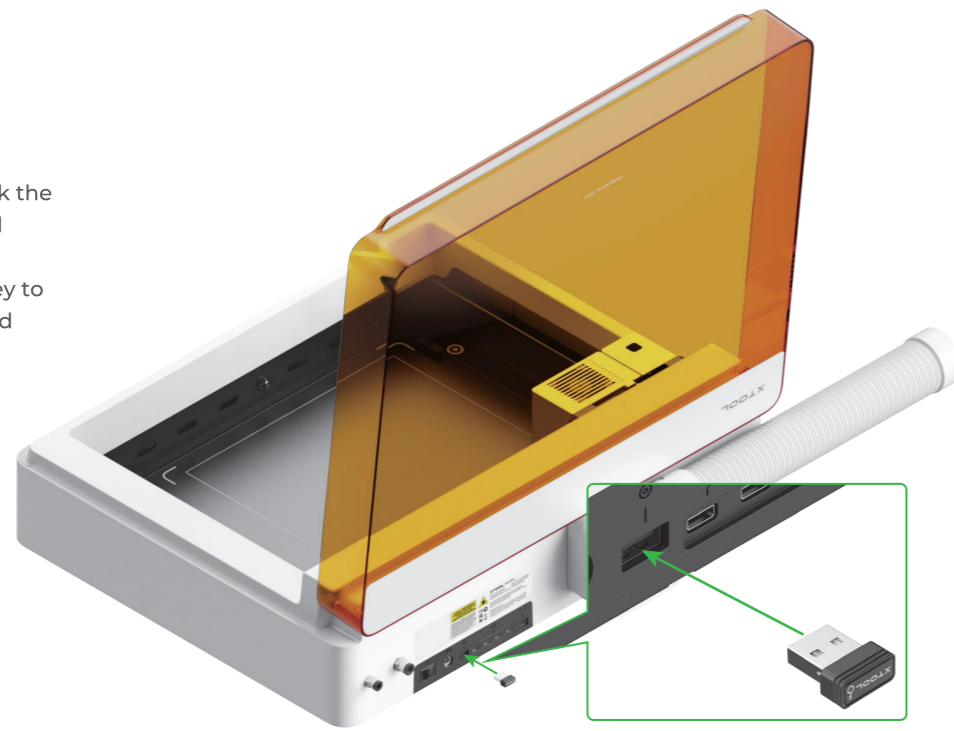

5

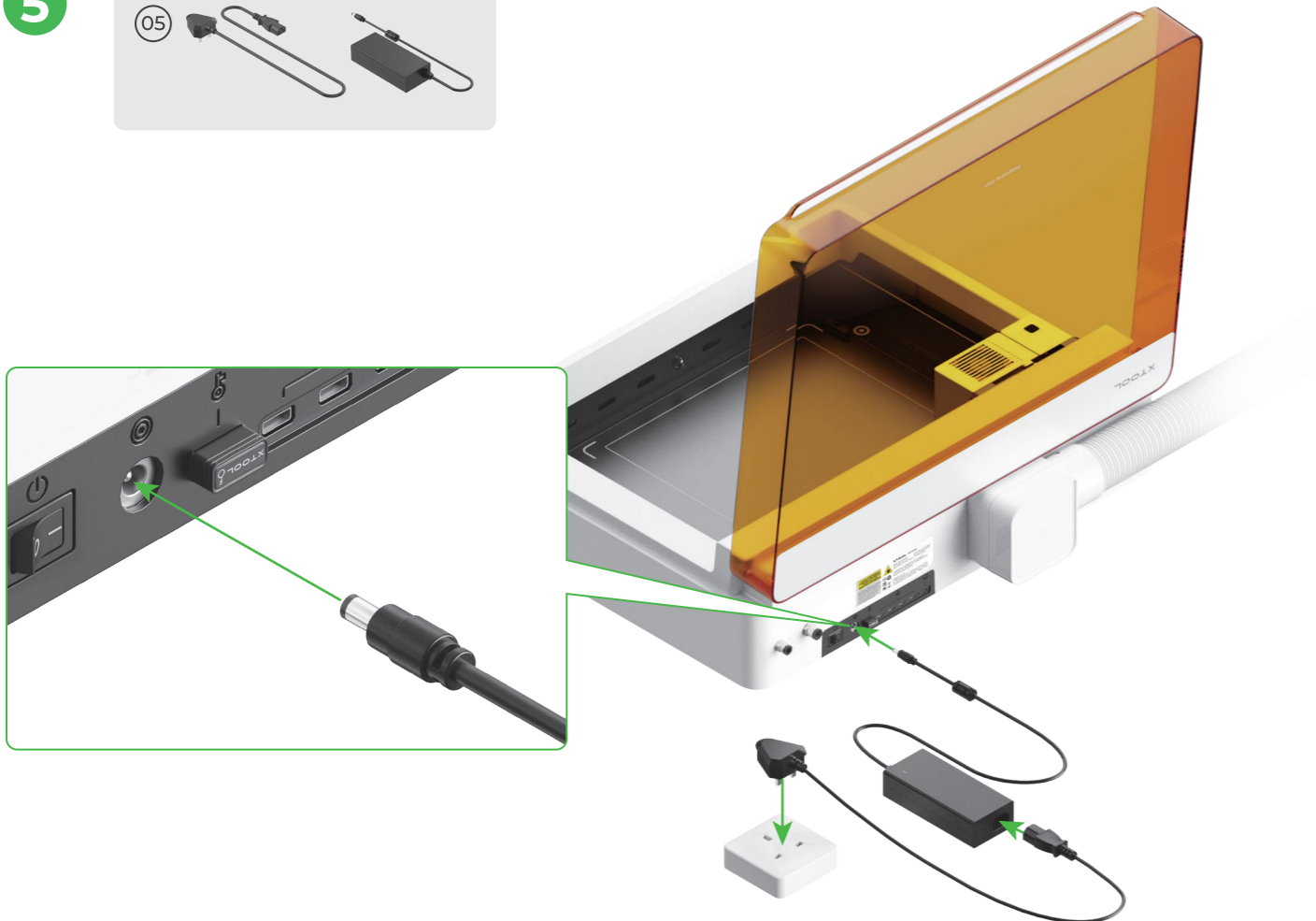
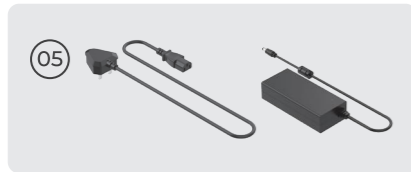

6

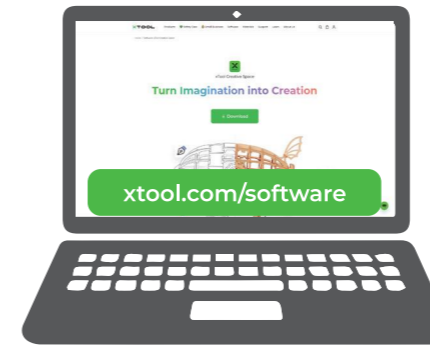

Go to xtool.com/software to download and install xTool Creative Space (XCS).

Search for **xTool Creative Space** in the App store or scan the following QR code to download the App.

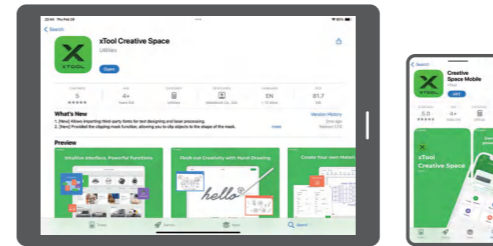

7

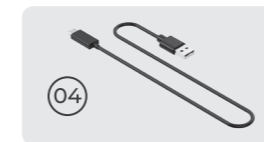

Turn on xTool M1 Ultra, connect it to a device, and then connect it on XCS.

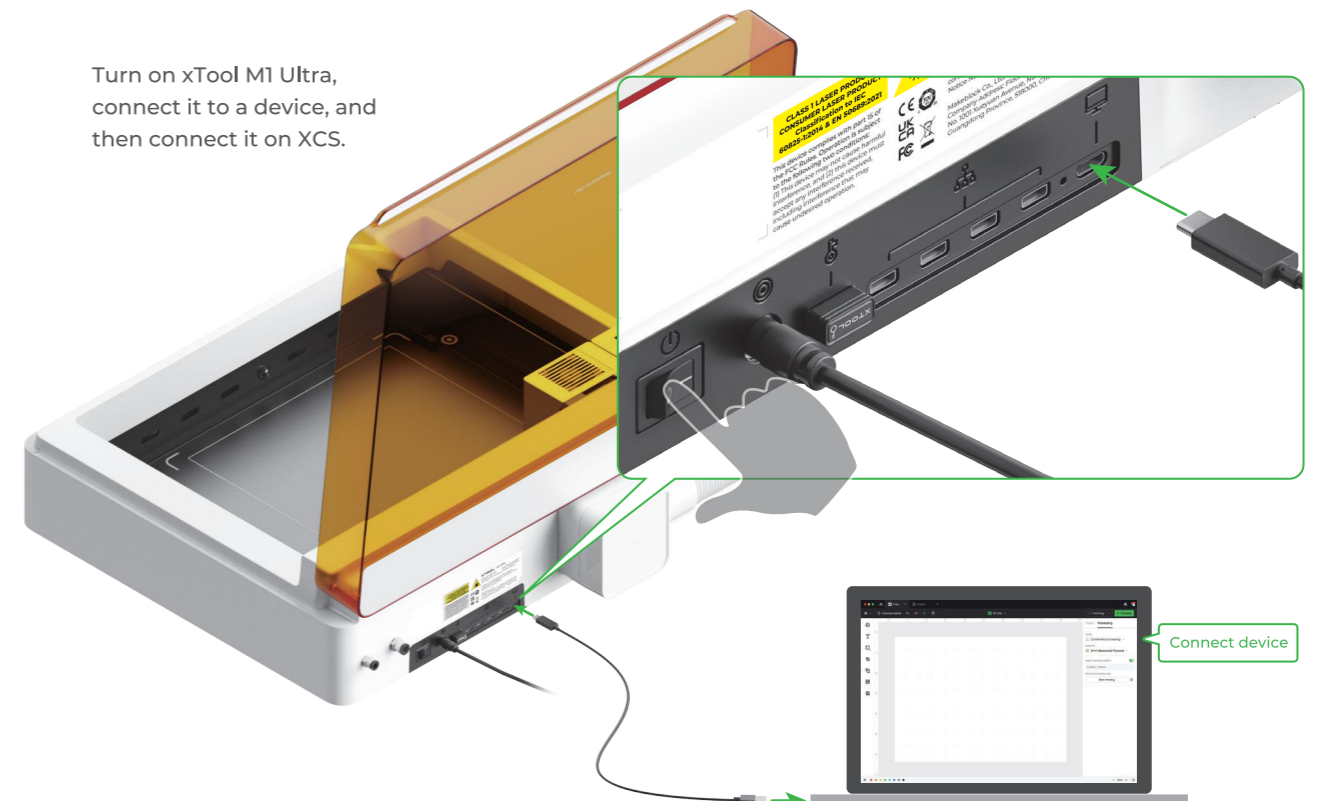

To know more details, scan the following QR code.



support@xtool.com

Use xTool M1 Ultra

For laser cutting

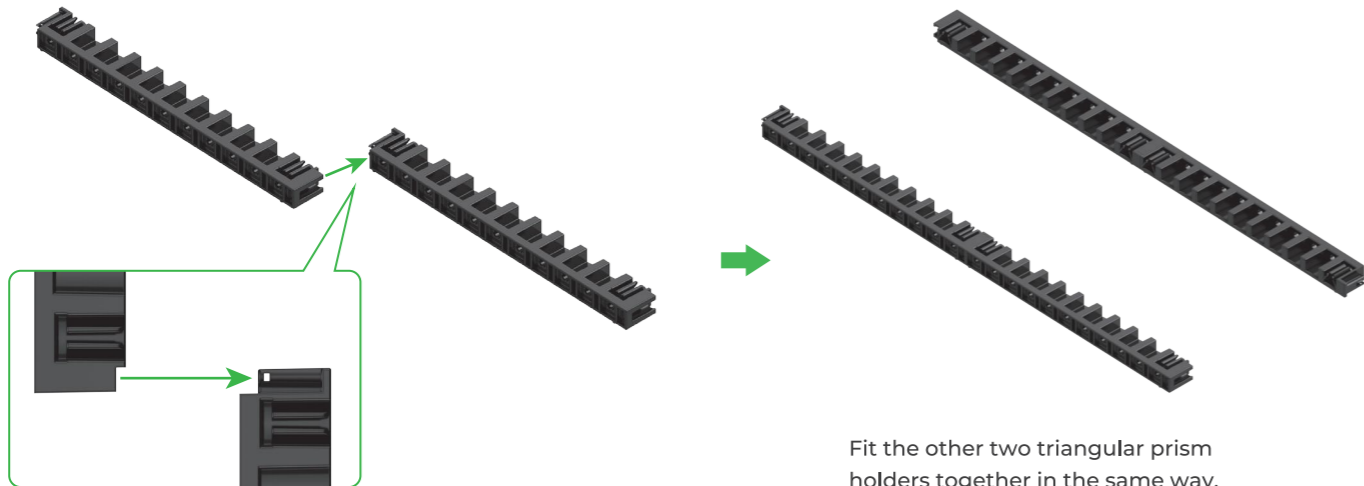
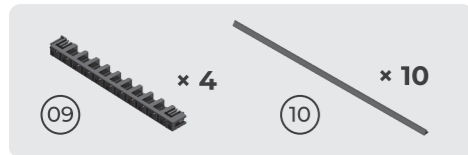

Fit the other two triangular prism holders together in the same way.

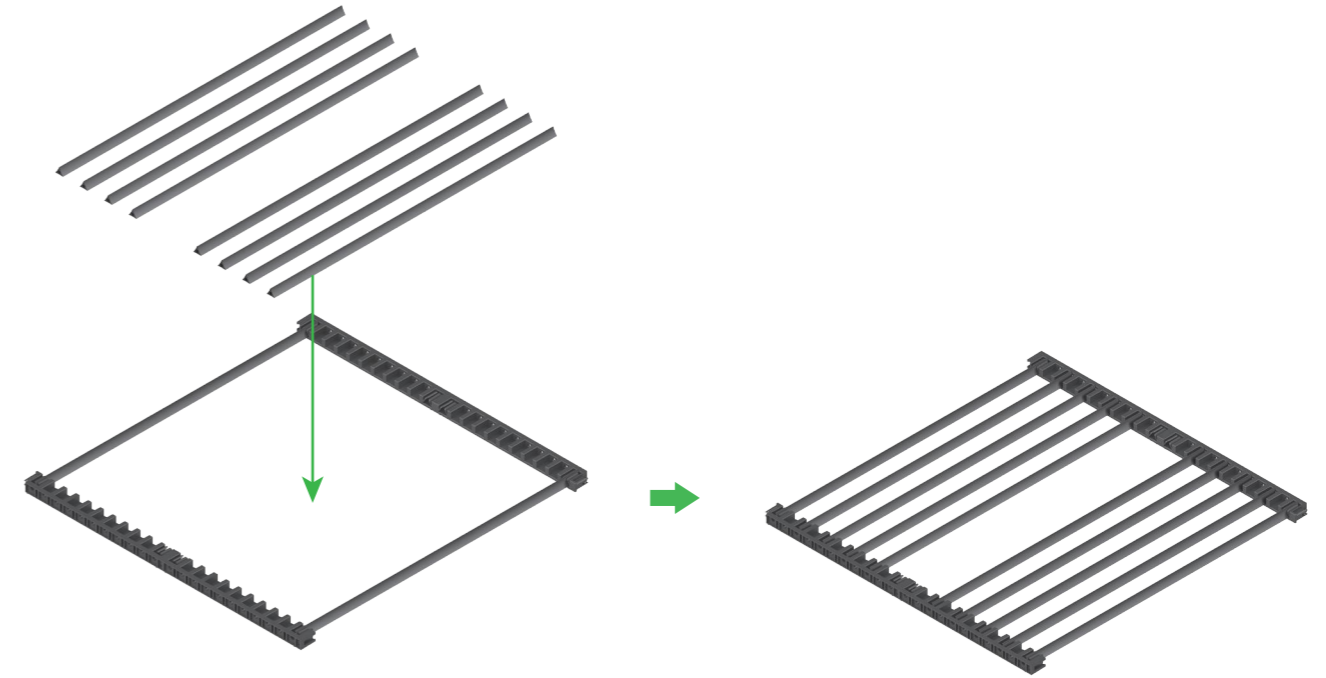
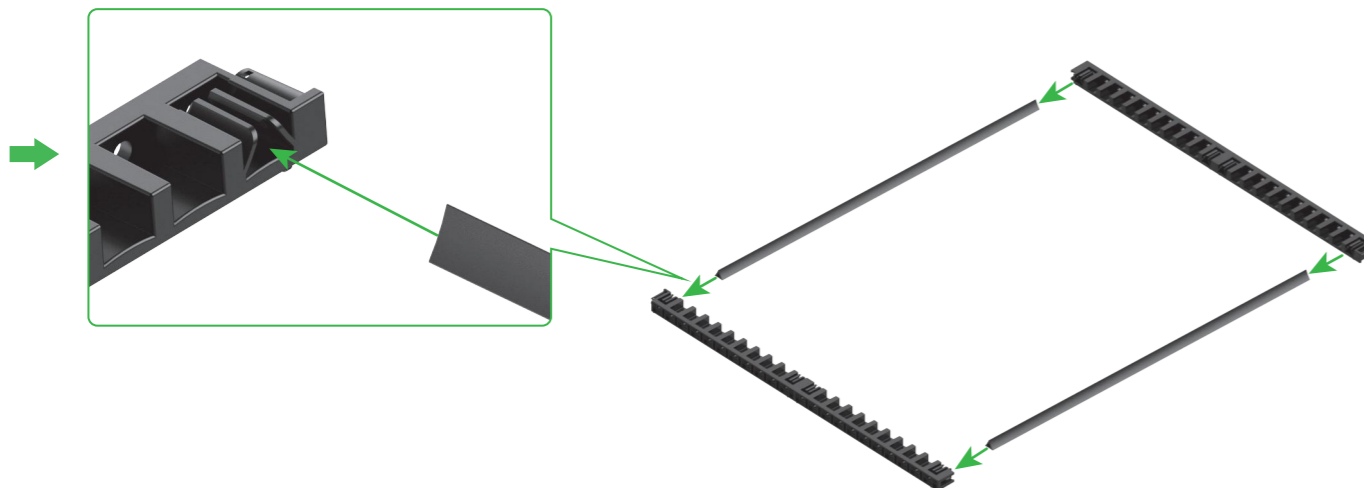

Determine the number of the triangular prisms based on the material to be processed.

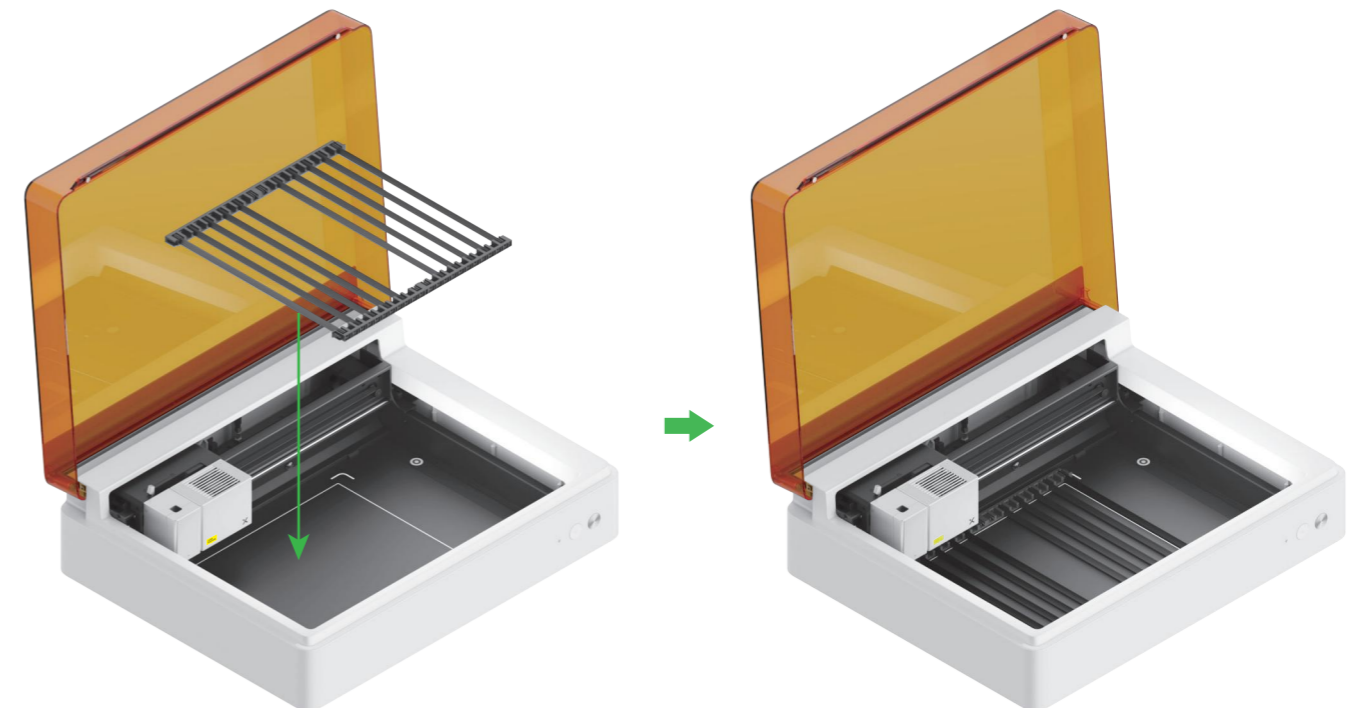

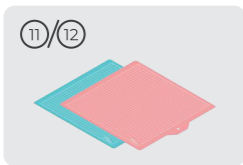

For blade cutting or combination of laser processing and blade cutting

1



Note: For paper materials such as cardboard and kraft paper, use the LightGrip cutting mat; and for fabric materials such as cloth, use the FabricGrip cutting mat.
Do not use any cutting mat when cutting a material with laser beams.

Cutting mat		
Color	Blue	Pink
Applicable to	Lightweight materials	Fabrics
Material	Cardboard, Wrapping paper, Printing paper Kraft paper, Pearl paper	Fabric

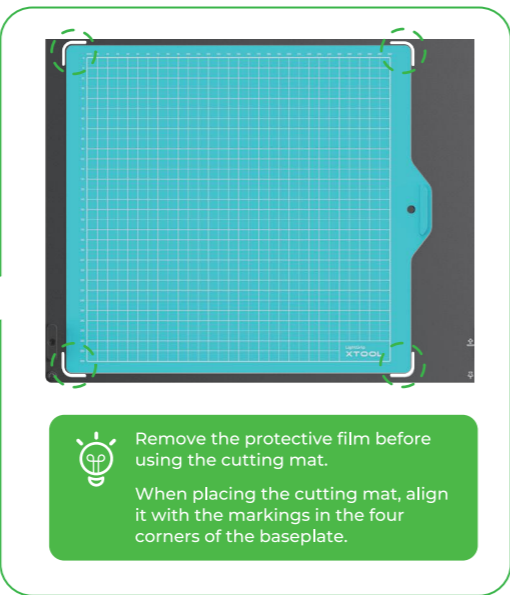
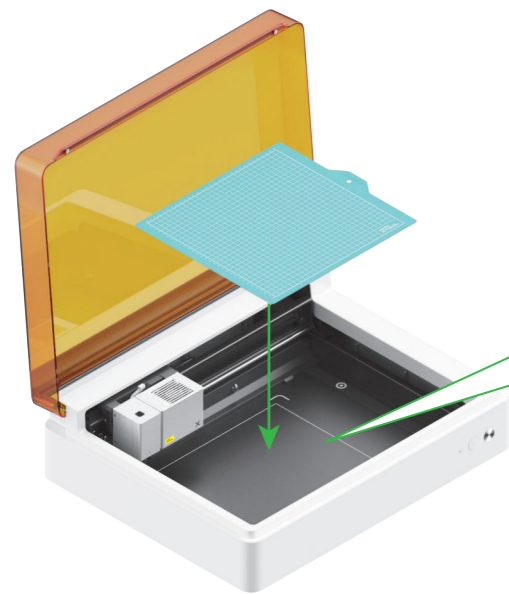

 Remove the protective film before using the cutting mat.
When placing the cutting mat, align it with the markings in the four corners of the baseplate.



2

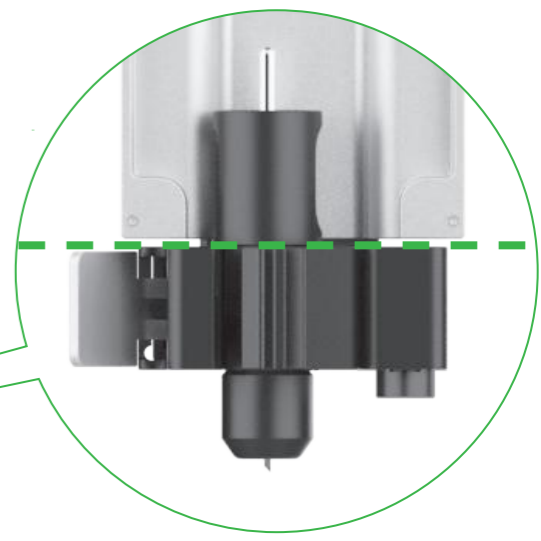
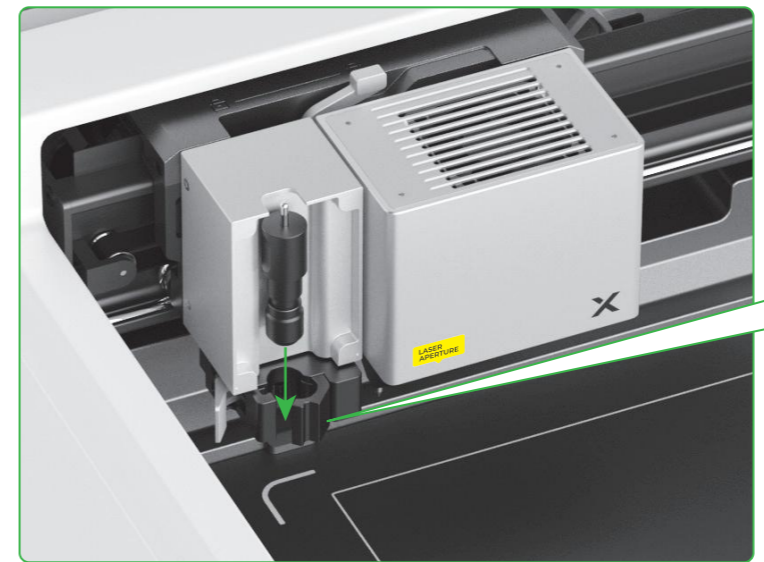
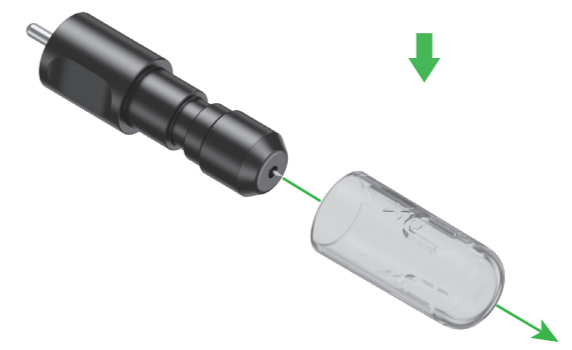
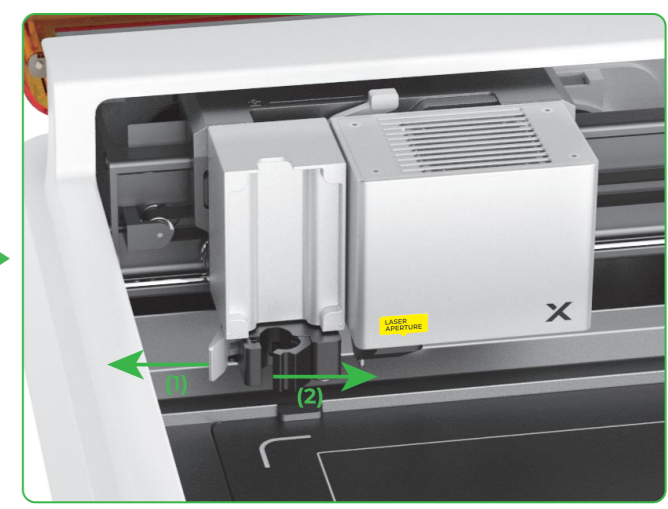
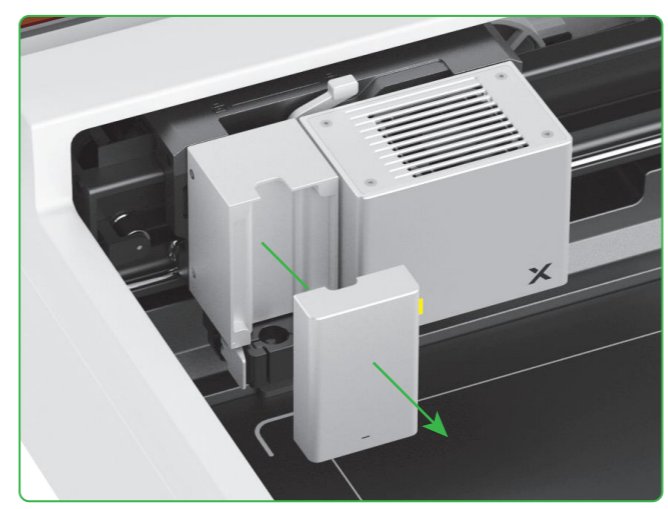

 **Caution!**
Sharp blade

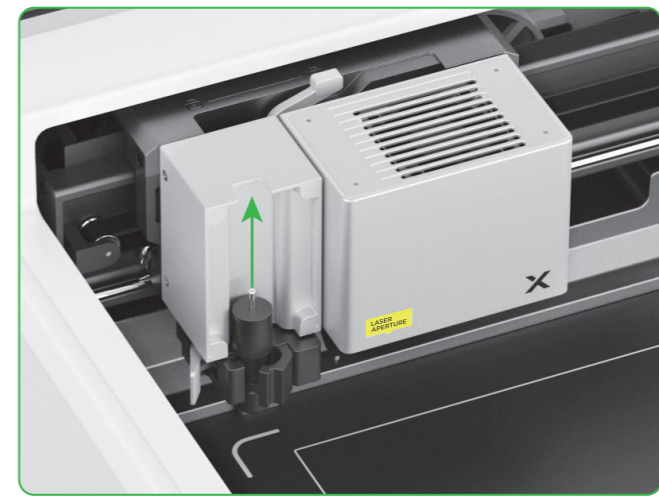
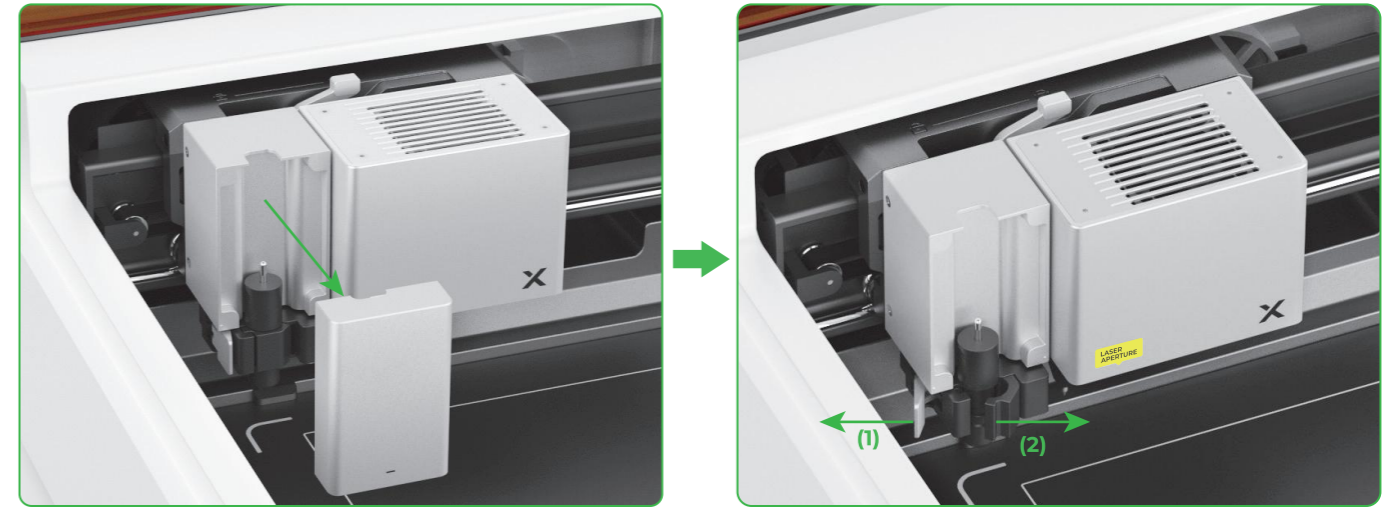
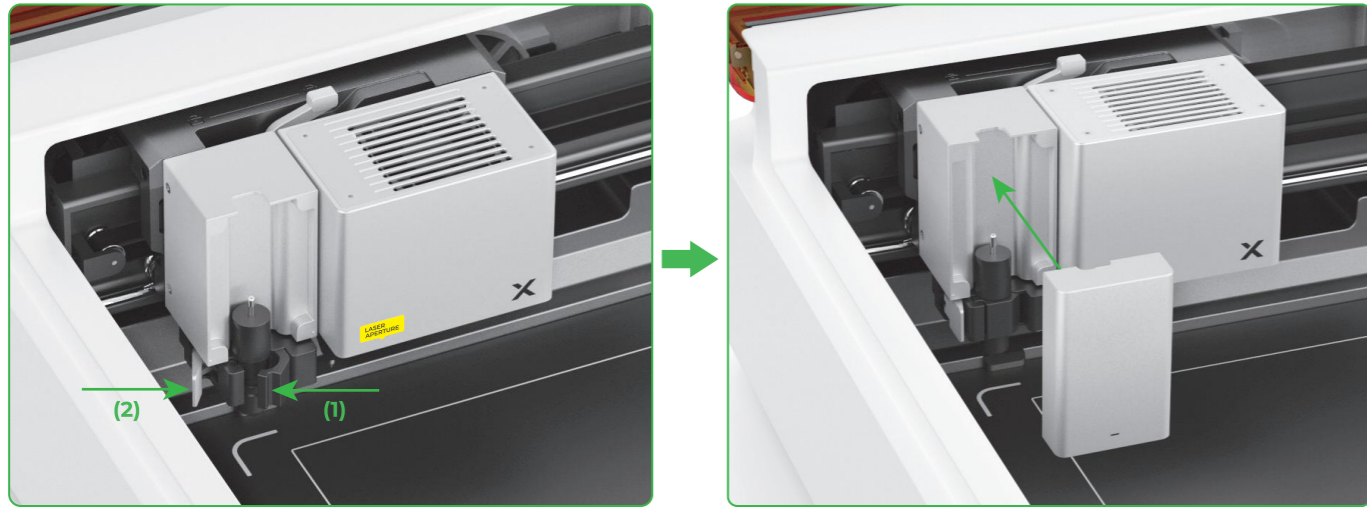

Caution!
Sharp blade

For pen drawing

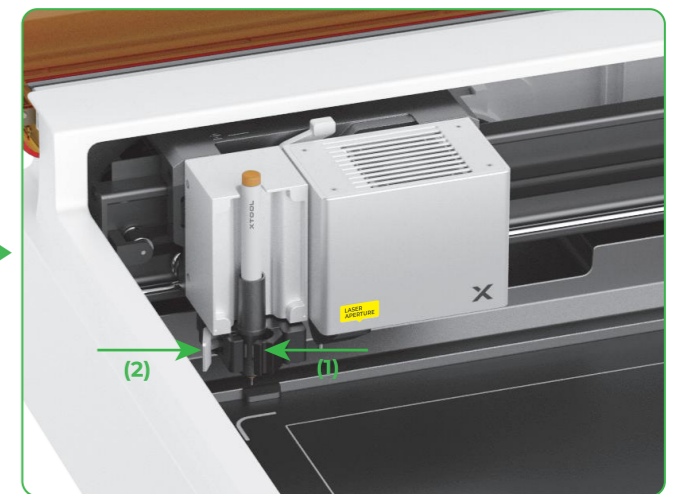
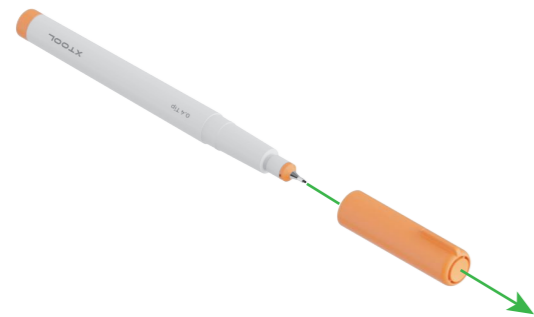

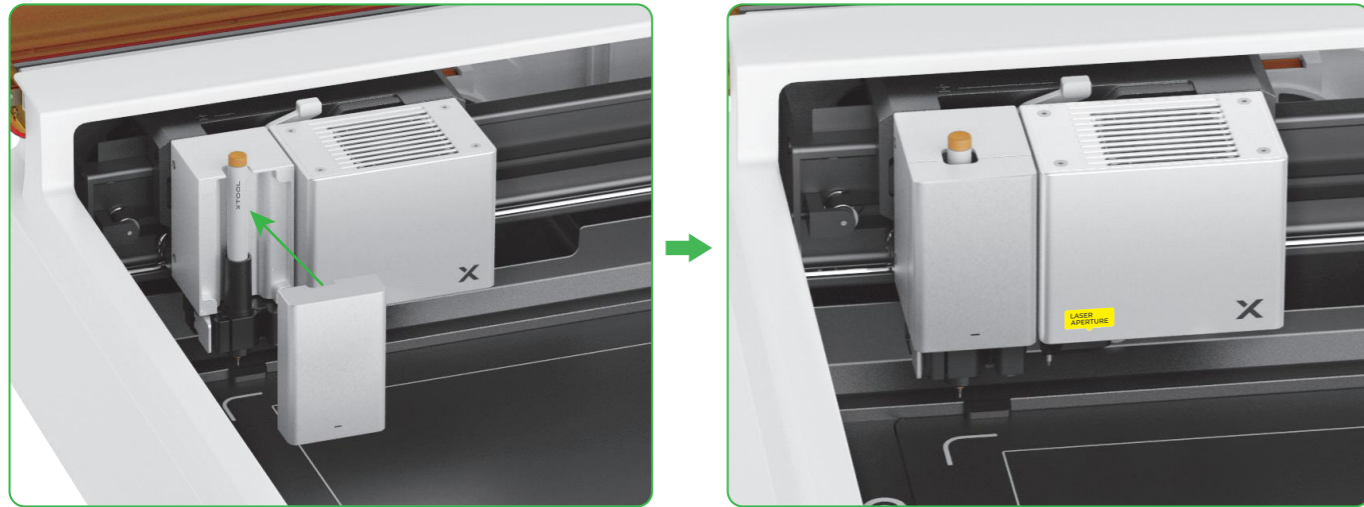

For more functions

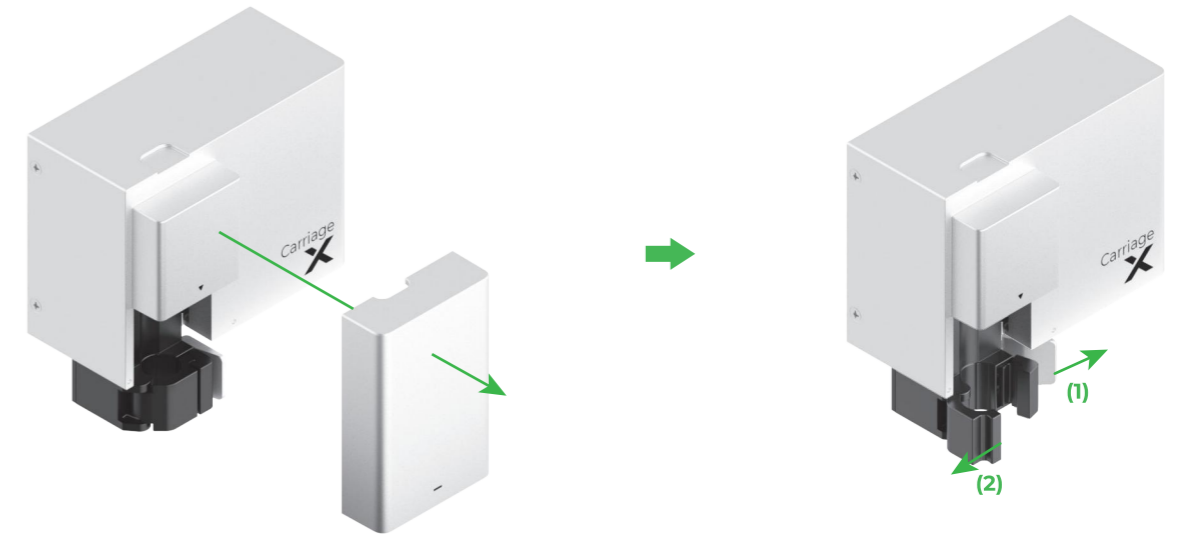
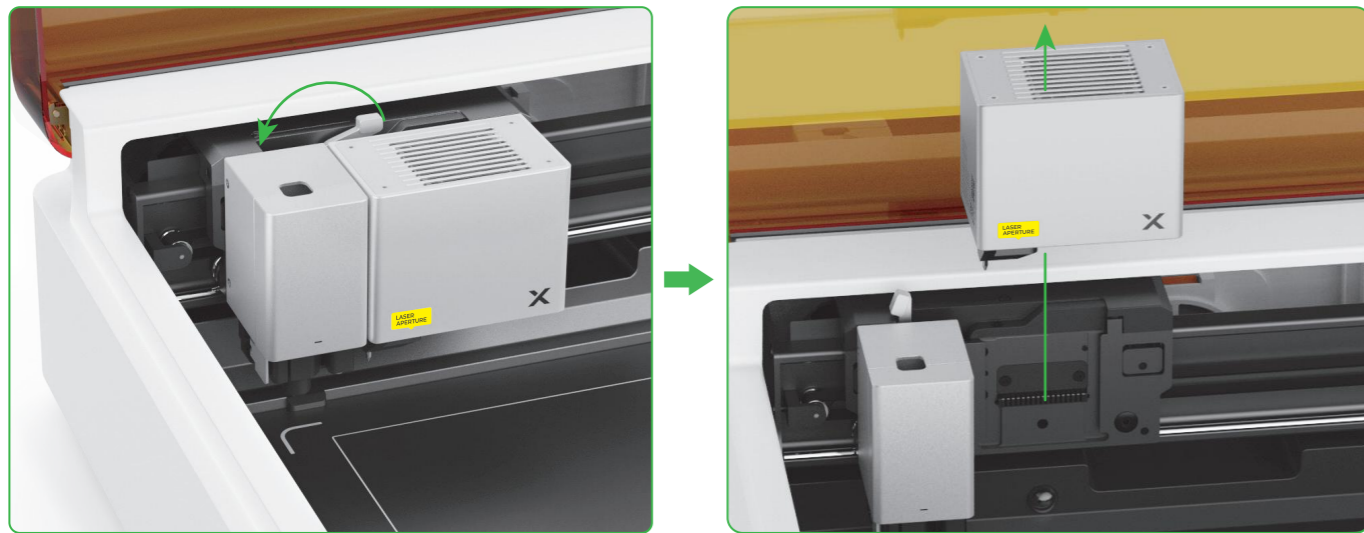
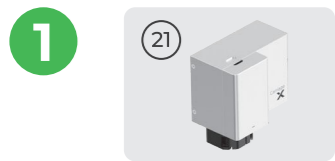

2 Select accessories according to the processing needs.

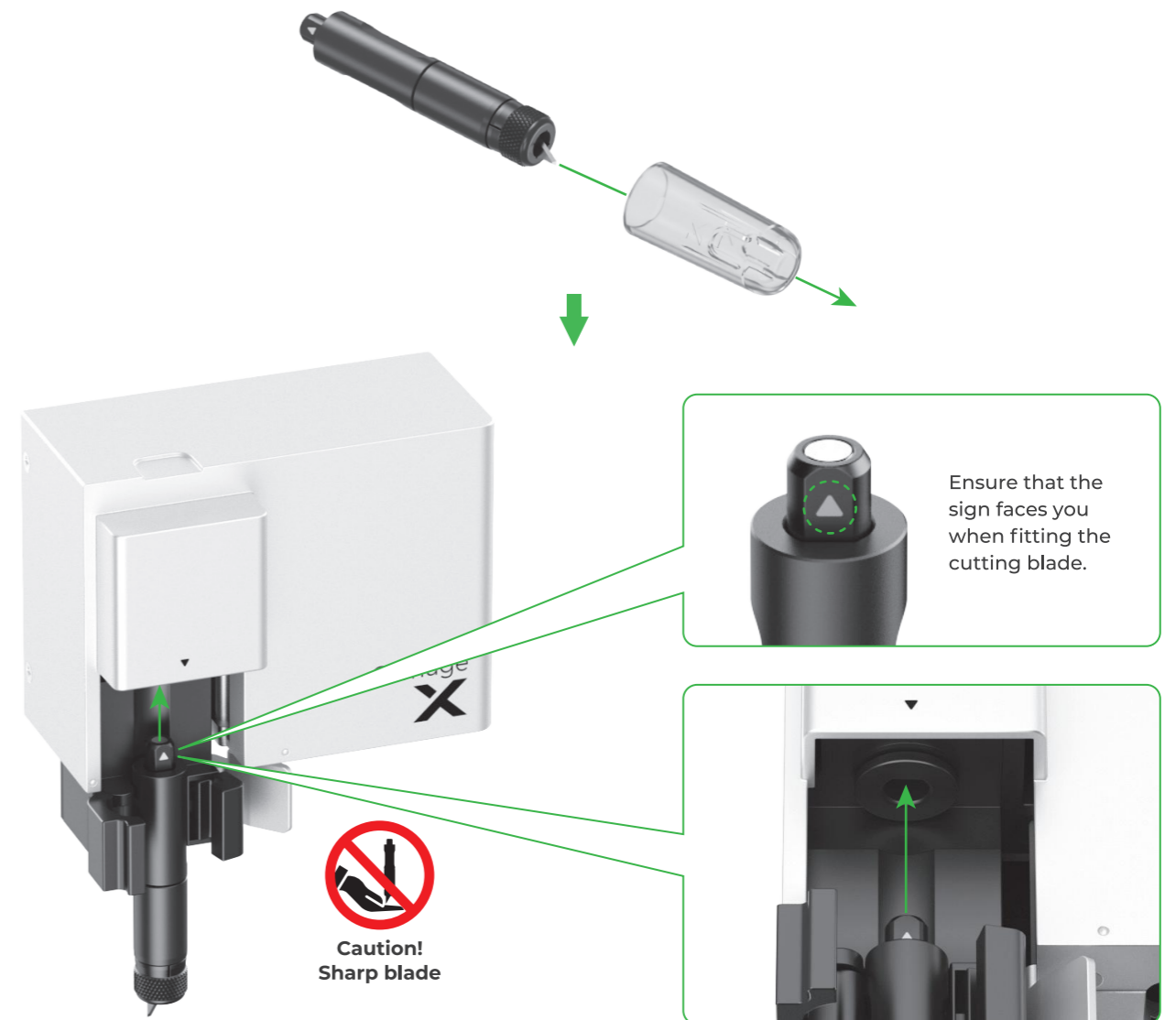

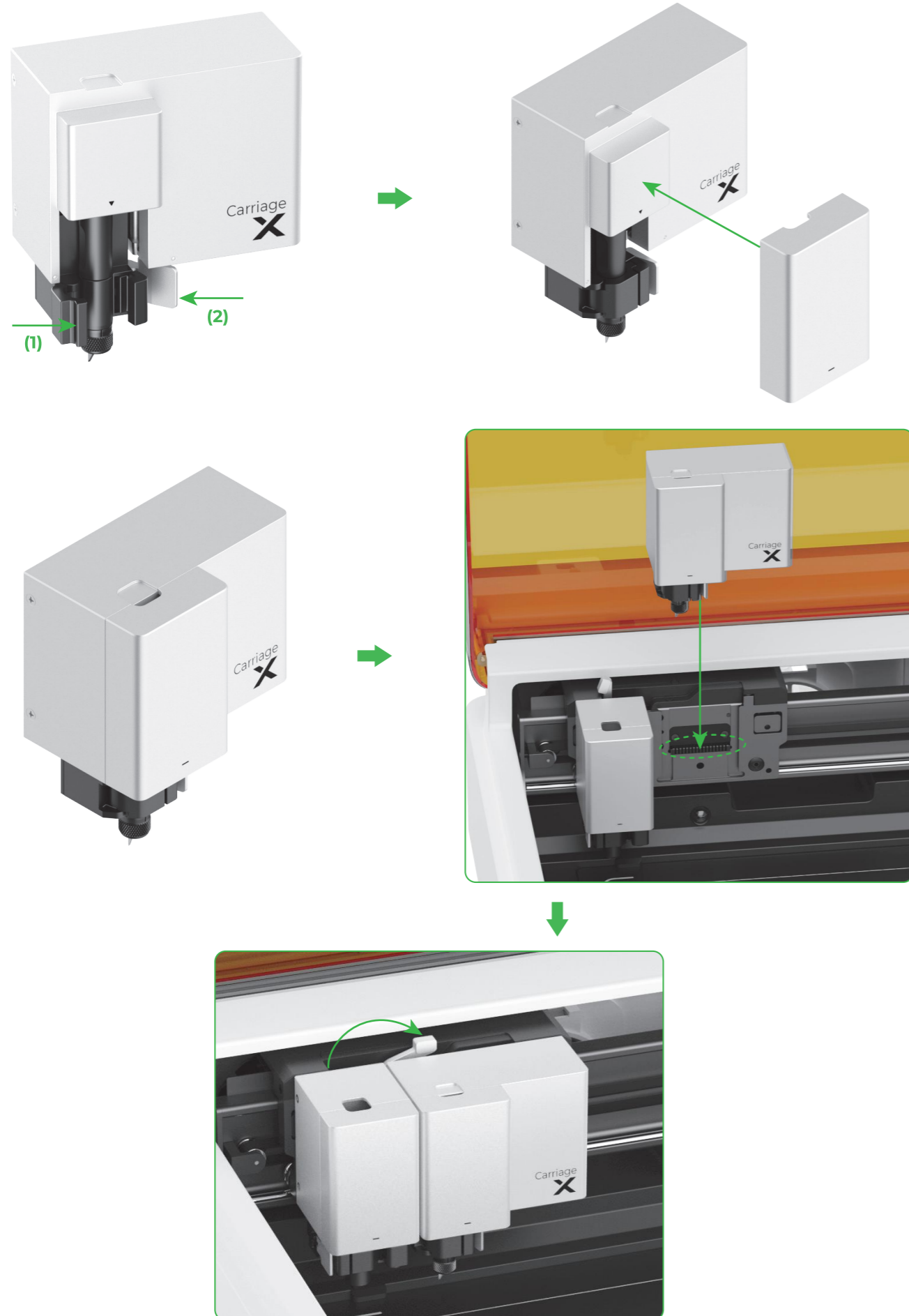

Indicator description

Indicator status	Buzzer status	Device status
○ Solid white	/	Standby, not connected to XCS (at AP mode)
○ Solid light blue	/	Standby, not connected to XCS (at STA mode)
○ Solid purple	Sounding once	Standby, connected to XCS
○ Breathing white	/	Sleeping, not connected to XCS
○ Breathing purple	/	Sleeping, connected to XCS
○ Blinking purple slowly	/	Firmware updating
○ Solid green	/	Processing area marking on XCS / Framing / Processing
○ Blinking blue slowly	Sounding once	Ready for framing / Ready to process
○ Solid blue	/	Task paused
○ Blinking yellow	Sounding once	The lid is open or not fully closed during operation.
○ Blinking yellow	Keeping sounding	Flame detected (small flame) / Device shaken
○ Blinking red	Keeping sounding	Flame detected (large flame)
○ Blinking yellow	Sounding three times	Exceptions occur
○ Blinking red	Sounding three times	Major exceptions occur

Maintenance

Replace the filter

13



Do not use the filter if it is moistened.



Replace the lens mount

18

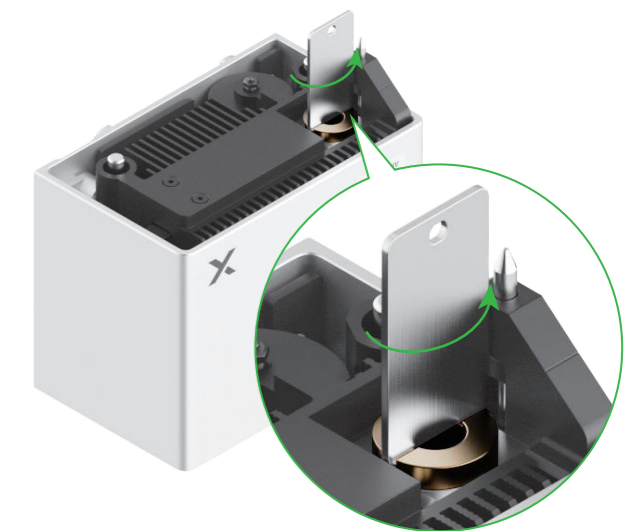
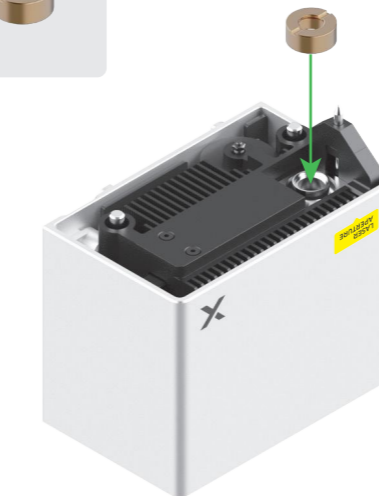
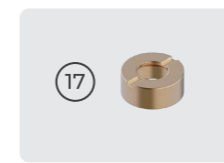
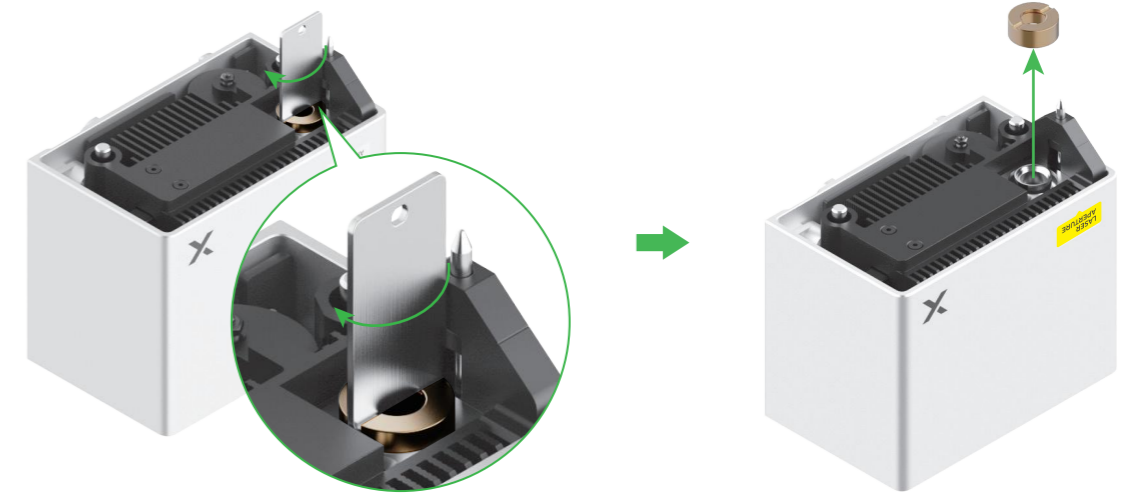
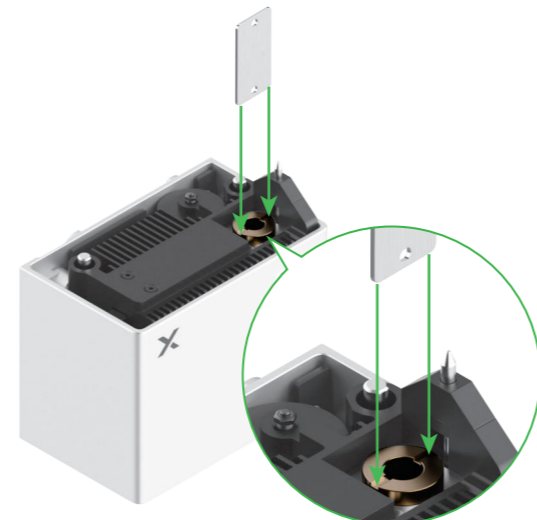
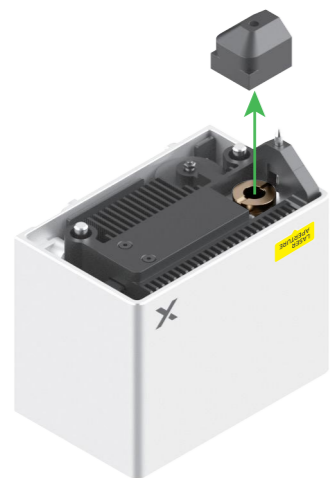
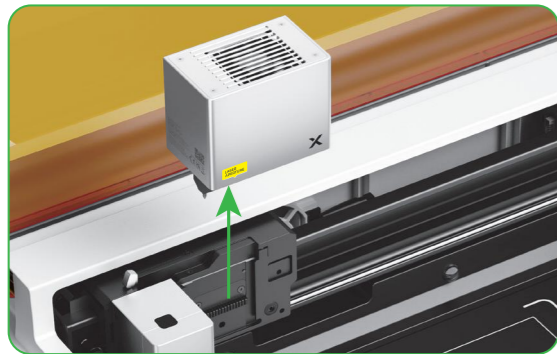

Clean the probe

The probe may get dirty after a long period of laser processing. Clean it in a timely manner, or the focusing accuracy may be reduced.

You are advised to clean the probe with a lint-free cloth moistened with alcohol.

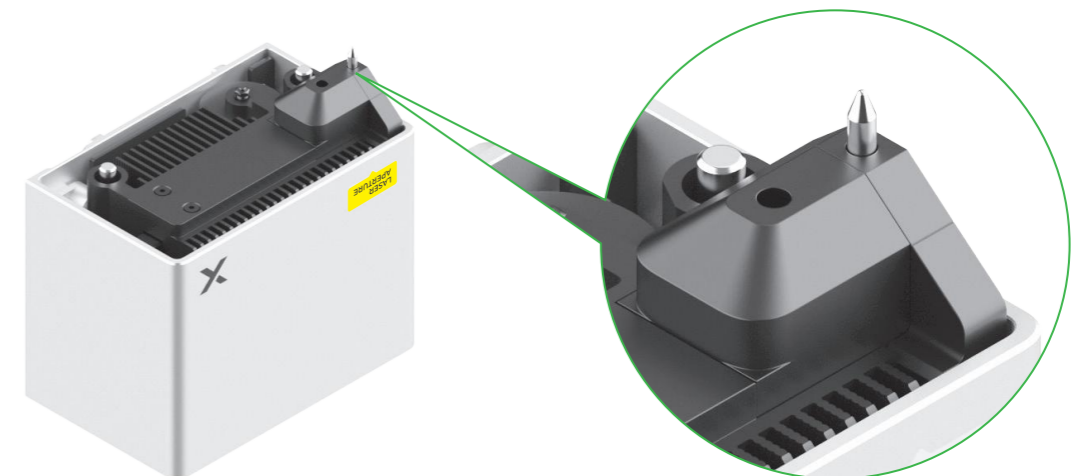

FAQs

1. The smoke exhaust module doesn't work during material processing. What can I do?

Possible causes:

Too much dust accumulates on the exhaust fan. / The filter gets blocked.

Solutions:

- (1) Turn off xTool M1 Ultra and remove the smoke exhaust module.
- (2) Replace the filter.
- (3) Install the smoke exhaust module back to xTool M1 Ultra.

2. The laser module / multi-function carriage doesn't work properly. Why?

Possible causes:

- The laser module / multi-function carriage is not installed properly.
- The locking bar above the laser module is not locked in place.

Solutions:

- Push the laser module / multi-function carriage down until you hear a click.
- After the laser module or multi-function carriage is fitted in place, toggle the locking bar to the right to lock it.

3. The baseplate or cutting mat is dirty due to long time processing. What can I do?

- Each time after you complete the processing, clean the baseplate or triangular prism with a cleaning cloth moistened with water and then dry it.
- If the baseplate is very dirty and hard to clean, wipe the dirt from it with a cleaning cloth moistened with absolute ethyl alcohol.

4. When do I need to replace the filter?

The replacement frequency varies according to material. You need to replace the filter when:

- A pop-up window on XCS prompts you to replace the filter.
- The smoke and fumes accumulate a lot inside the device.

5. When I use an orange pen for processing, I can't see the lines drawn by the pen. Why?

Because the lid is orange.

Declaration of conformity

Hereby, Makeblock Co., Ltd., declares that this product is in compliance with the essential requirements and other relevant provisions of Directive RED 2014/53/EU and the RoHS directive 2011/65/EU.

FCC statement

This device complies with Part 15 of the FCC Rules. Operation is subject to the following two conditions:
(1) This device may not cause harmful interference, and (2) This device must accept any interference received, including interference that may cause undesired operation.

Warning: Changes or modifications not expressly approved by the party responsible for compliance could void the user's authority to operate the equipment.

NOTE: This equipment has been tested and found to comply with the limits for a Class B digital device, pursuant to Part 15 of the FCC Rules.

These limits are designed to provide reasonable protection against harmful interference in a residential installation. This equipment generates uses and can radiate radio frequency energy and, if not installed and used in accordance with the instructions, may cause harmful interference to radio communications. However, there is no guarantee that interference will not occur in a particular installation. If this equipment does cause harmful interference to radio or television reception, which can be determined by turning the equipment off and on, the user is encouraged to try to correct the interference by one or more of the following measures:

- Reorient or relocate the receiving antenna.
- Increase the separation between the equipment and receiver.
- Connect the equipment into an outlet on a circuit different from that to which the receiver is connected.
- Consult the dealer or an experienced radio/TV technician for help.

FCC Radiation Exposure Statement

This equipment complies with FCC radiation exposure limits set forth for an uncontrolled environment. This equipment should be installed and operated with minimum distance 20cm between the radiator & your body.

This device complies with Industry Canada licence-exempt RSS standard (s). Operation is subject to the following two conditions:

(1) this device may not cause interference, and (2) this device must accept any interference, including interference that may cause undesired operation of the device.

Le présent appareil est conforme aux CNR d'Industrie Canada applicables aux appareils radio exempts de licence. L'exploitation est autorisée aux deux conditions suivantes :
(1) l'appareil n'a pas de produire de brouillage, et (2) l'utilisateur de l'appareil doit accepter tout brouillage radioélectrique subi, même si le brouillage est susceptible d'en compromettre le fonctionnement.

After-sales services

For technical support, contact us at support@xtool.com. For more information about after-sales services, visit support.xtool.com.

DEE

Erklärung	26
Sicherheit geht vor (wichtig)	26
Liste der Teile	28
xTool M1 Ultra kennenlernen	30
Vorbereitungen	32
xTool M1 Ultra verwenden	36
Beschreibung der Kontrollleuchte	45
Wartung	46
Häufig gestellte Fragen	48
Konformitätserklärung	48
Kundendienst	48

Erklärung

Vielen Dank, dass Sie sich für xTool-Produkte entschieden haben!

Wenn Sie das Produkt zum ersten Mal benutzen, lesen Sie bitte sorgfältig das gesamte Begleitmaterial des Produkts durch. Wenn Sie das Produkt nicht gemäß den Anweisungen und Anforderungen des Handbuchs verwenden oder das Produkt fehlerhaft betreiben, übernimmt das Unternehmen keine Verantwortung für daraus resultierende Schäden.

Das Unternehmen hat den Inhalt des Handbuchs sorgfältig und gewissenhaft zusammengestellt, aber es können Fehler oder Auslassungen bestehen.

Das Unternehmen ist bestrebt, die Produktfunktionen und die Servicequalität ständig zu verbessern, und behält sich daher das Recht vor, die im Handbuch beschriebenen Produkte oder Software sowie den Inhalt des Handbuchs jederzeit zu ändern.

Das Handbuch soll Ihnen helfen, das Produkt richtig zu benutzen und enthält keine Beschreibung der Hardware- und Softwarekonfiguration. Für die Produktkonfiguration lesen Sie bitte den zugehörigen Vertrag (falls vorhanden) und die Packliste oder wenden Sie sich an Ihren Händler. Die Abbildungen in diesem Handbuch dienen nur als Referenz und das tatsächliche Produkt kann davon abweichen.

Die Anleitung ist urheberrechtlich geschützt. Ohne vorherige schriftliche Genehmigung seitens des Unternehmens darf die Anleitung weder auf irgendeine Weise reproduziert, umgeschrieben, auf irgendeine Weise über ein kabelgebundenes oder kabelloses Netzwerk übertragen oder in irgendeine Sprache übersetzt werden, noch dürfen irgendwelche Änderungen daran vorgenommen werden, beispielsweise in Bezug auf Inhalt, Abbildungen oder Layout.

Das Unternehmen hat es sich zur Aufgabe gemacht, das Produkt und die damit verbundenen Materialien stetig zu verbessern. Das Produkt und die Gebrauchsanleitung können verändert werden. Aktualisierungen sind unter xtool.com zu finden.

Sicherheit geht vor (wichtig)

1. Allgemeine Sicherheit

Machen Sie sich mit allen Sicherheitsmaßnahmen und -verfahren vertraut, bevor Sie die Maschine verwenden. Die Anwender müssen alle nachstehenden Vorsichtsmaßnahmen strikt befolgen und sicherstellen, dass der xTool M1 Ultra ordnungsgemäß funktioniert.



Bitte beachten Sie die folgenden Funktionsprinzipien:

- Überprüfen Sie den xTool M1 Ultra vor jedem Gebrauch auf Schäden. Betreiben Sie keinen beschädigten oder defekten xTool M1 Ultra.
- Bitte halten Sie den Arbeitsbereich sauber und eben.
- Bitte zerlegen oder verändern Sie den Aufbau des xTool M1 Ultra nicht ohne Genehmigung und modifizieren oder dekompileieren Sie das Betriebssystem des xTool M1 Ultra nicht.

■ Lassen Sie die Maschine nicht unbeaufsichtigt, wenn sie in Betrieb ist. Achten Sie darauf, ob die Maschine ordnungsgemäß funktioniert.

■ Bitte halten Sie das Innere des xTool M1 Ultra sauber. Die sich beim Schneiden und Gravieren ansammelnden Rückstände und Späne sind gefährlich und können Feuer verursachen. Beseitigen Sie Späne und Rückstände regelmäßig aus dem Arbeitsbereich.

■ Die Arbeitstemperatur des Lasers liegt zwischen 0°C und 35°C, die Lagertemperatur beträgt -10°C und 40°C. Es ist strikt verboten, unter 0°C zu arbeiten.

■ Dieses Produkt kann nicht vom Benutzer gewartet werden. Es muss an das Werk zurückgeschickt oder von autorisierten Fachleuten repariert werden.

2. Sicherheit des Lasers

Grundsätzlich sind die Laser-Module während des Betriebs vollständig vom Gehäuse und dem Lichtschutz umschlossen. Der xTool M1 Ultra verfügt über einen Sicherheitsverriegelungsschalter. Wenn der Deckel während des Betriebs angehoben wird, unterbricht der xTool M1 Ultra seine Arbeit.



Bitte beachten Sie die folgenden Sicherheitsrichtlinien:

■ Bitte beachten Sie, dass das Fehlen von Teilen des xTool M1 Ultra das Lasersystem freilegen und das Risiko einer Beschädigung der Ausrüstung erhöhen kann.

■ Gravieren oder schneiden Sie kein Material, das PVC oder Vinyl enthält (verarbeitete Kunststoffe werden nicht empfohlen). Diese Materialien (und andere Materialien, die Chlor/Chlorid enthalten) können korrosive Dämpfe erzeugen, die äußerst schädlich für den menschlichen Körper sind und den xTool M1 Ultra beschädigen können. Alle Schäden, die durch Gravieren oder Schneiden von Material, das PVC oder Vinyl enthält, verursacht werden, sind nicht durch die Garantie des Unternehmens abgedeckt.

■ Gravieren oder schneiden Sie kein unbekanntes Material. Das Verdampfen/Schmelzen vieler Materialien, wie zum Beispiel bei PVC und Polycarbonat führt zur Freisetzung von schädlichem Rauch.

■ Der Laserbetrieb ist verboten, wenn der Deckel angehoben ist. Vergewissern Sie sich, dass der xTool M1 Ultra während des Betriebs durch den Deckel verschlossen ist und manipulieren Sie nicht den Sicherheitsmechanismus des Deckels.

■ Lassen Sie die Maschine nicht unbeaufsichtigt, wenn sie in Betrieb ist. Achten Sie darauf, ob die Maschine ordnungsgemäß funktioniert.

Die Referenznormen für Lasersicherheit sind der American National Standard for Safe Use of Lasers (Z136.1-2022), die Norm der Internationalen Elektrotechnischen Kommission (IEC 60825-1:2014) und die europäischen Normen (EN 60825-1:2014/A11:2021 und EN 50689:2021).

3. Brandsicherheit



Ein hochenergetischer, sehr feiner Laserstrahl wird im xTool M1 Ultra verwendet, um das zu schneidende oder zu gravierende Material zu

bestrahlen, und so die Materialoberfläche zu erwärmen und das Material zu verdampfen, ohne es zu verbrennen. Die meisten Materialien sind jedoch von Natur aus entflammbar und können sich entzünden und dabei eine offene Flamme bilden, welche den xTool M1 Ultra (auch wenn er aus schwer entflammbaren Materialien besteht) und seine Umgebung entzünden kann. Die Erfahrung zeigt, dass beim Vektorschneiden mit einem Laser am ehesten eine offene Flamme entsteht.



Bitte lesen Sie die nachfolgenden Warnhinweise und Vorschläge sorgfältig durch:

■ Geräte zur Verwendung an Orten, an denen sich Kinder wahrscheinlich nicht aufhalten.

■ Achten Sie auf eine ausreichende Belüftung des Arbeitsbereichs, damit der entstehende Rauch sofort abgeleitet werden kann.

■ Aufgestapelte Materialien (insbesondere organische Materialien wie Papier) können eine Ausbreitung von Flammen verursachen oder das Risiko einer Selbstentzündung des Materials erhöhen. (insbesondere das Ende des Rauchabzugsrohrs)

■ Lassen Sie den xTool M1 Ultra während des Betriebs niemals unbeaufsichtigt. Es besteht Brandgefahr, wenn der xTool M1 Ultra aufgrund falscher Einstellungen gestartet und über einen längeren Zeitraum unbeaufsichtigt gelassen wird oder wenn der xTool M1 Ultra während des Betriebs mechanisch oder elektrisch fehlerhaft arbeitet.

■ Reinigen Sie den xTool M1 Ultra regelmäßig. Eine übermäßige Ansammlung von Rückständen und Spänen beim Schneiden und Gravieren wird die Brandgefahr erhöhen. Der interne Arbeitsbereich muss regelmäßig gereinigt werden, damit sich im Gerät keine Rückstände oder Späne ansammeln können.

■ Halten Sie den Bereich um den xTool M1 Ultra herum sauber und frei von brennbaren Materialien, Sprengstoffen oder flüchtigen Lösungsmitteln wie Aceton, Alkohol oder Benzin.

■ Halten Sie einen Feuerlöscher bereit, und führen Sie regelmäßige Wartung und Inspektion durch.

■ Passen Sie gut auf sich auf, wenn während der Verarbeitung ein Feuer ausbricht. Bei einer kleinen Flamme können Sie warten, bis es ausgeht; bei einem größeren Feuer sollten Sie einen Sicherheitsabstand einhalten und es mit einem Feuerlöscher löschen.

■ Es wird empfohlen, beim Gravieren oder Schneiden von brennbaren Materialien mit dem Laserstrahl das xTool-Feuerschutzset zu verwenden, um Brände zu vermeiden.

4. Sicherheit elektrischer Geräte



Bitte lesen Sie die folgenden Warnungen und Vorschläge sorgfältig durch und beachten Sie sie strikt:

■ Wenn der xTool M1 Ultra mit der Stromversorgung verbunden ist, dürfen Sie keine Zugangsklappe am xTool M1 Ultra öffnen, sonst kann der unbeabsichtigte Kontakt mit der Stromversorgung zu Verletzungen führen.

■ Wenn der xTool M1 Ultra an die Stromversorgung angeschlossen ist, berühren Sie den elektronikbezogenen Bereich nicht mit Ihren Händen oder anderen Werkzeugen.

5. Wartung



Vorsicht - Die Verwendung von Bedienelementen oder Einstellungen oder die Durchführung von Verfahren, die nicht in dieser Anleitung beschrieben sind, kann zu einer gefährlichen Strahlenbelastung führen.

Lesen Sie die folgenden Warnhinweise und Empfehlungen sorgfältig durch:

■ Trennen Sie das Gerät von der Stromversorgung, bevor Sie es warten.

■ Achten Sie beim Ausbauen des Lasermoduls oder Messers darauf, dass Ihre Finger nicht mit dem Messer in Berührung kommen, da sonst Verletzungsgefahr besteht.

■ Die Messer sind sehr scharf. Verletzen Sie sich beim Einbau oder Austausch der Messer nicht die Hände.

■ Legen Sie die gebrauchten Messer in einen Behälter, der stabil genug ist, um Verletzungsgefahr auszuschließen, beispielsweise eine Dose aus Metall, verschließen Sie den Behälter fest und entsorgen Sie ihn.

6. Warn- und Hinweisschilder

Alle an Ihrem xTool M1 Ultra angebrachten Warn- und Informationsschilder befinden sich an Orten, die vor und/oder während des Betriebs eine Gefahrenquelle darstellen können. Beschädigte oder verloren gegangene Warn- und Informationsschilder müssen sofort ersetzt werden. Die fehlenden Warn- und Informationsschilder können mit Hilfe der Vorlagen auf der folgenden Seite nachgedruckt werden.

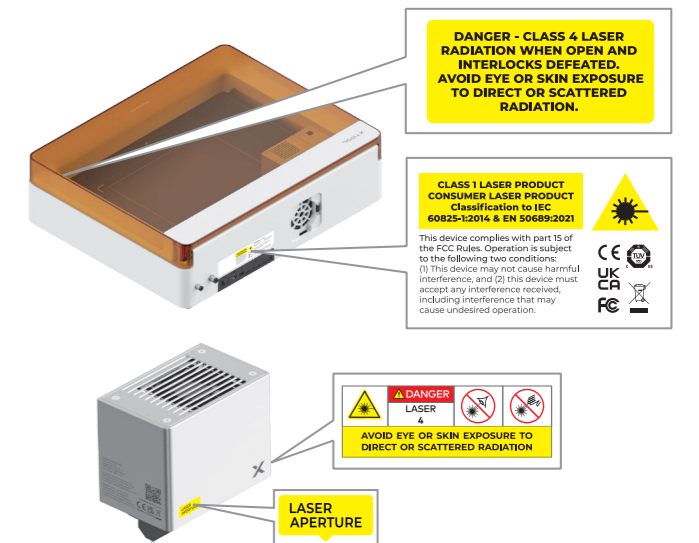

Maximale RF-Sendeleistung: Wi-Fi 2.4G (2412-2472 MHz) < 20 dBm

Lasers Spezifikationen

	Wellenlänge	Strahldivergenz	Maximale Ausgangsleistung
Arbeitslaser	455±5nm	1.5mrad (IEC 60825-1 Default (simplified) evaluation C6=1)	20 W
Indikator-Laser	650±5nm	/	0.39 mW

Liste der Teile

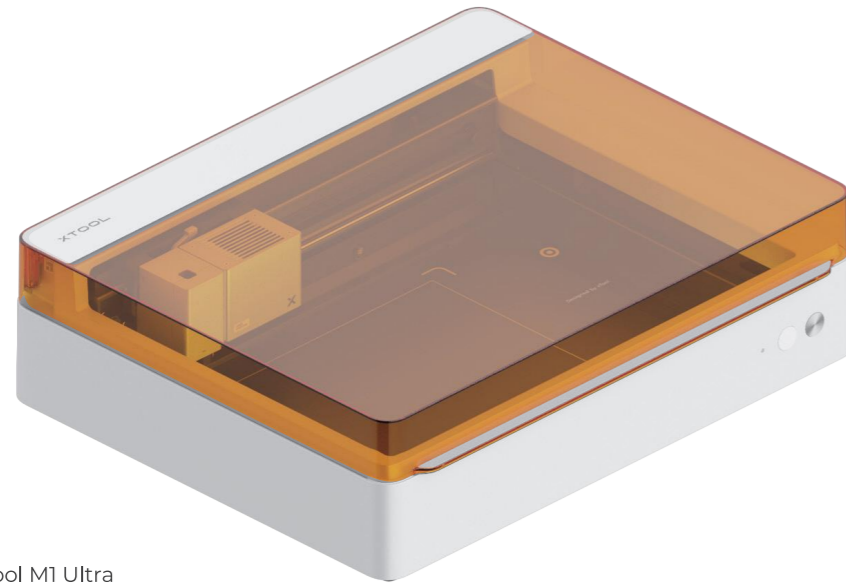

01 xTool M1 Ultra



02 Lasermodul



03 Abgasmodul



04 USB-Kabel

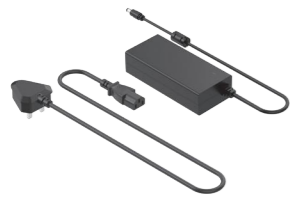

05 Netzteil und Kabel



06 Feinspitzenmesser



07 Dünner Stift



08 Stifthalter

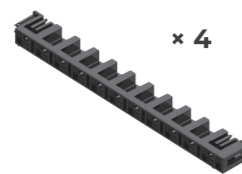

09 Dreiecksprisma-Halter

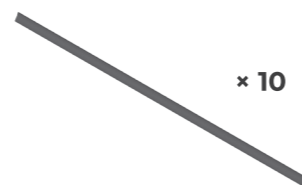

10 Dreiecksprisma

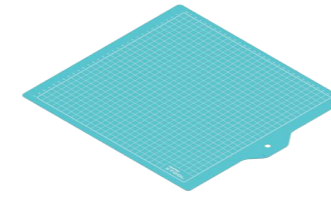

11 Schneidematte (LightGrip)

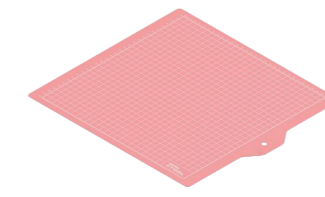

12 Schneidematte (FabricGrip)



13 Filter



14 Schlüssel



15 Schmierfett



16 Material-Paket

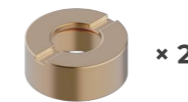

17 Linsenhalter (Ersatzteil)



18 Linsenhalter-Drehteil



19 Schraubenzieher



20 Benutzerhandbuch



21 Multifunktionsträger



22 Schneidmesser

xTool M1 Ultra kennenlernen

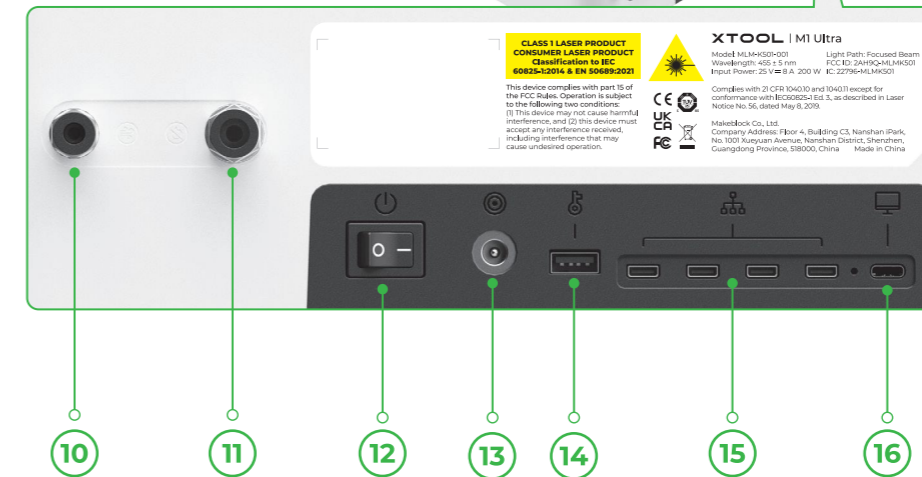
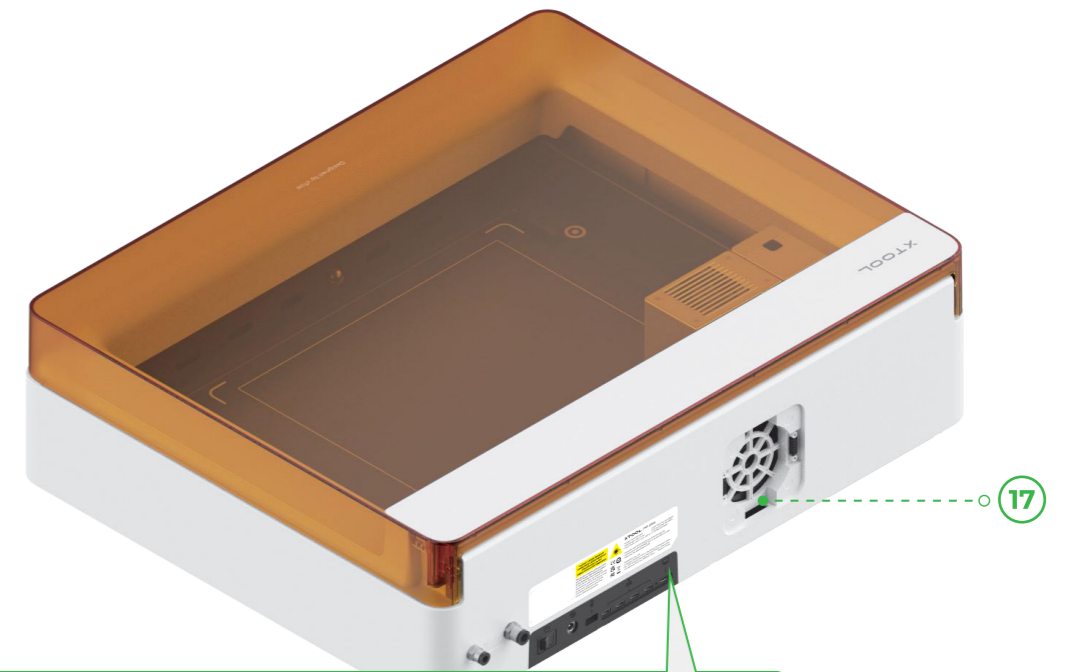
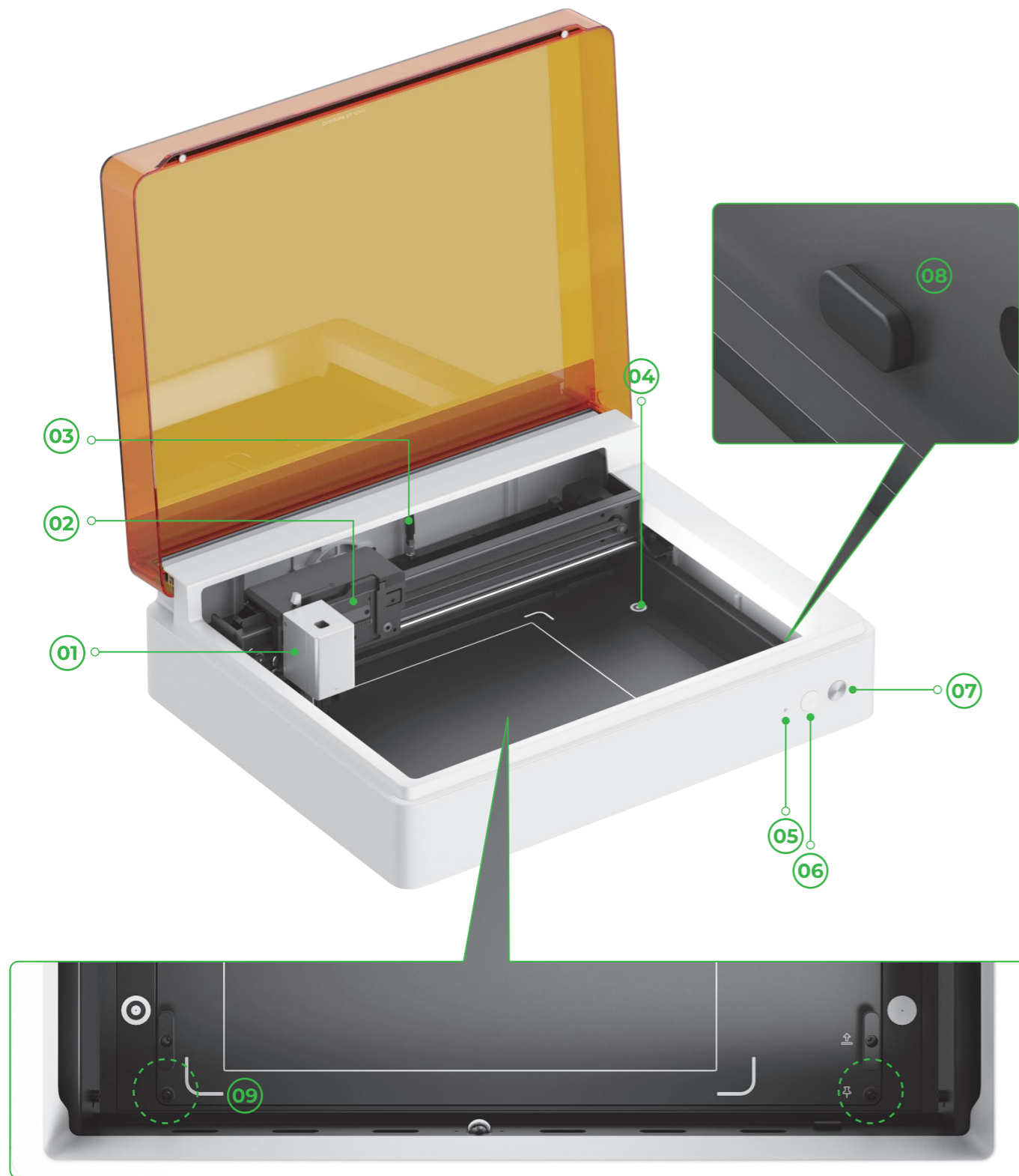

- | | | | | | |
|----|-----------------------|----|---|----|---------------------------|
| 01 | Basisträger | 07 | Start/Stop-Taste | 13 | Stromanschluss |
| 02 | Multifunktionshalter | 08 | Drehvorrichtungsanschluss | 14 | Anschluss für Schlüssel |
| 03 | WLAN-Antenne | 09 | Rändelschraube für die Sockelplatte | 15 | Erweiterungsanschluss × 4 |
| 04 | Kamerasucherpunkt | 10 | Schlauchanschluss für den Air Assist | 16 | USB-Anschluss |
| 05 | Anzeige | 11 | Schlauchanschluss für das Brandschutzsystem | 17 | Rauchaustritt |
| 06 | Punktmarkierungstaste | 12 | Ein-/Aus-Schalter | | |

Vorbereitungen

1

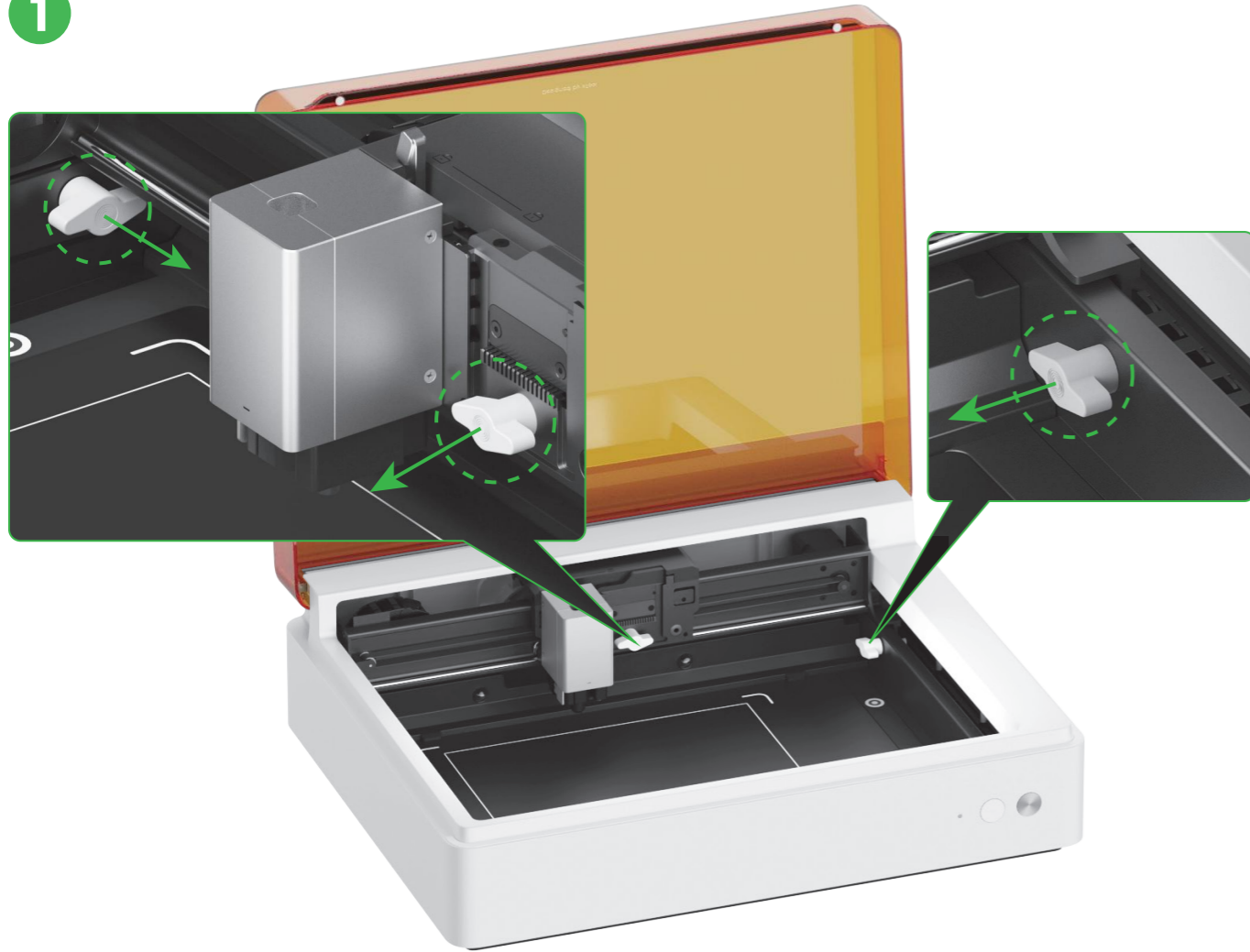

2

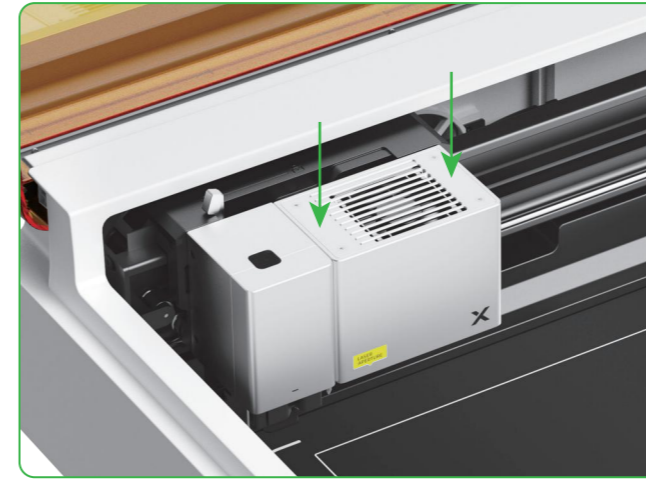
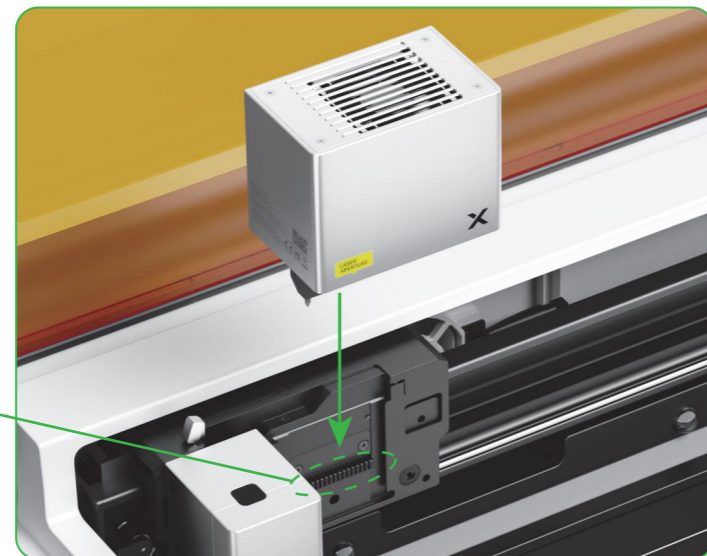

Drücken Sie das Lasermodul nach unten, bis es hörbar einrastet.



3



Verwenden Sie das Abgasmodul nicht ohne den Filter. Andernfalls absorbiert es Rauch und Staub und nimmt Schaden.

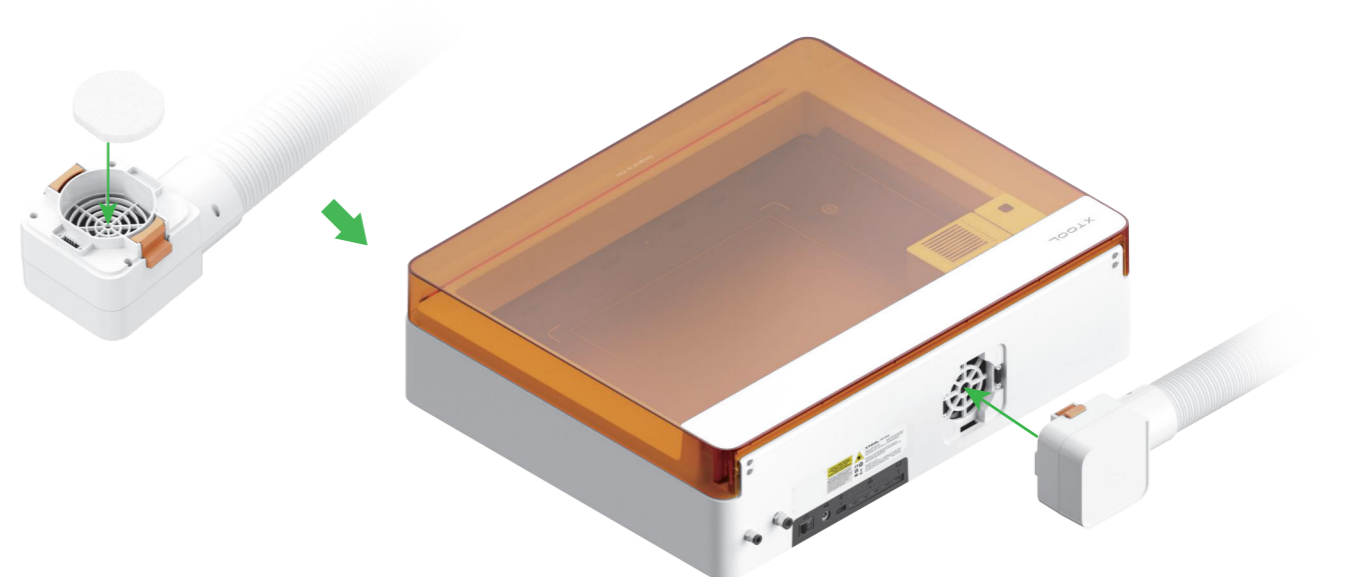

4

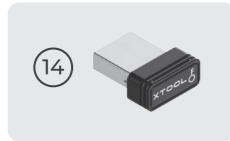

Stecken Sie den Schlüssel ein, um die Bearbeitung sowie zugehörige Funktionen zu entsperren.
Sie können den Schlüssel abziehen, um die Bearbeitung sowie zugehörige Funktionen zu sperren.

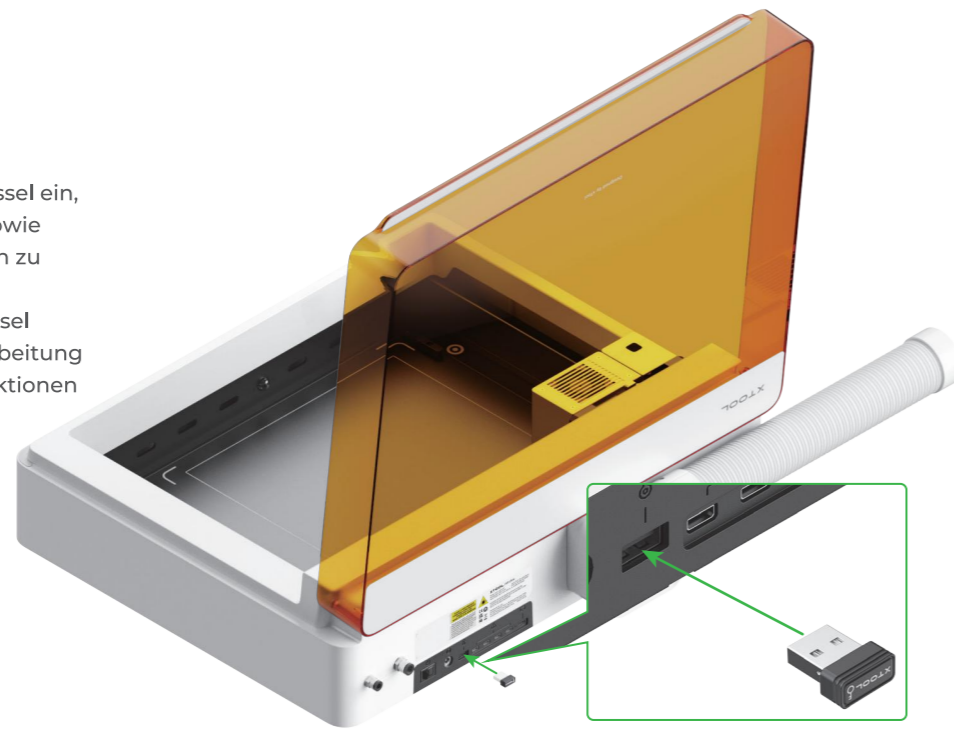

5

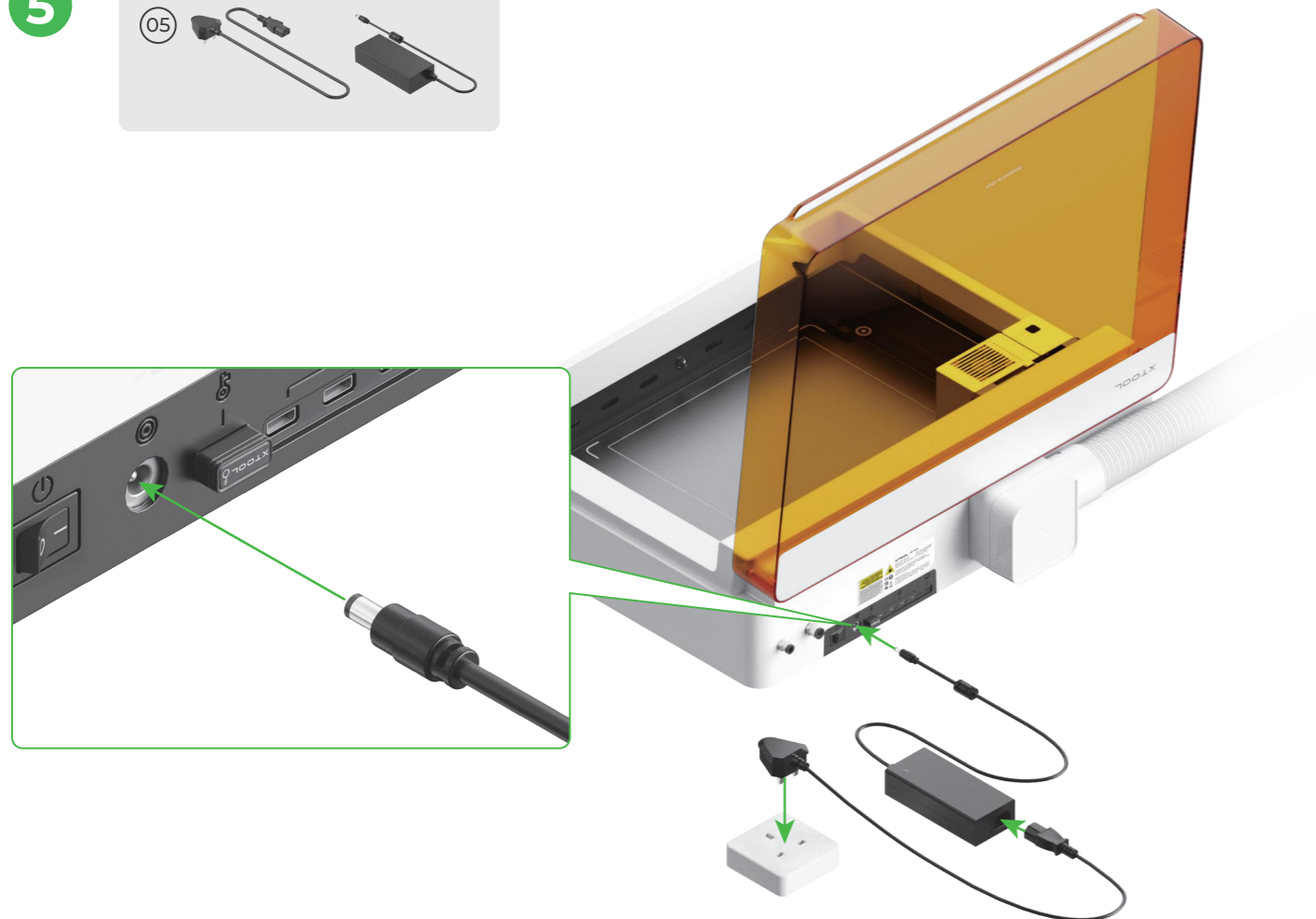
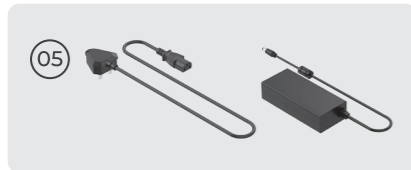

6



Unter xtool.com/software können Sie xTool Creative Space (XCS) herunterladen und anschließend installieren.

Suchen Sie in einem App-Store nach **xTool Creative Space** oder scannen Sie den folgenden QR-Code, um die App herunterzuladen.

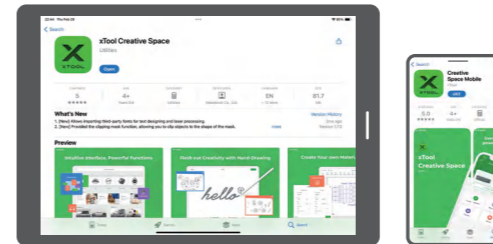

7

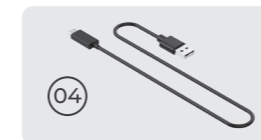

Schalten Sie den xTool M1 Ultra ein, schließen Sie ihn an ein Gerät an und verbinden Sie ihn dann mit XCS.

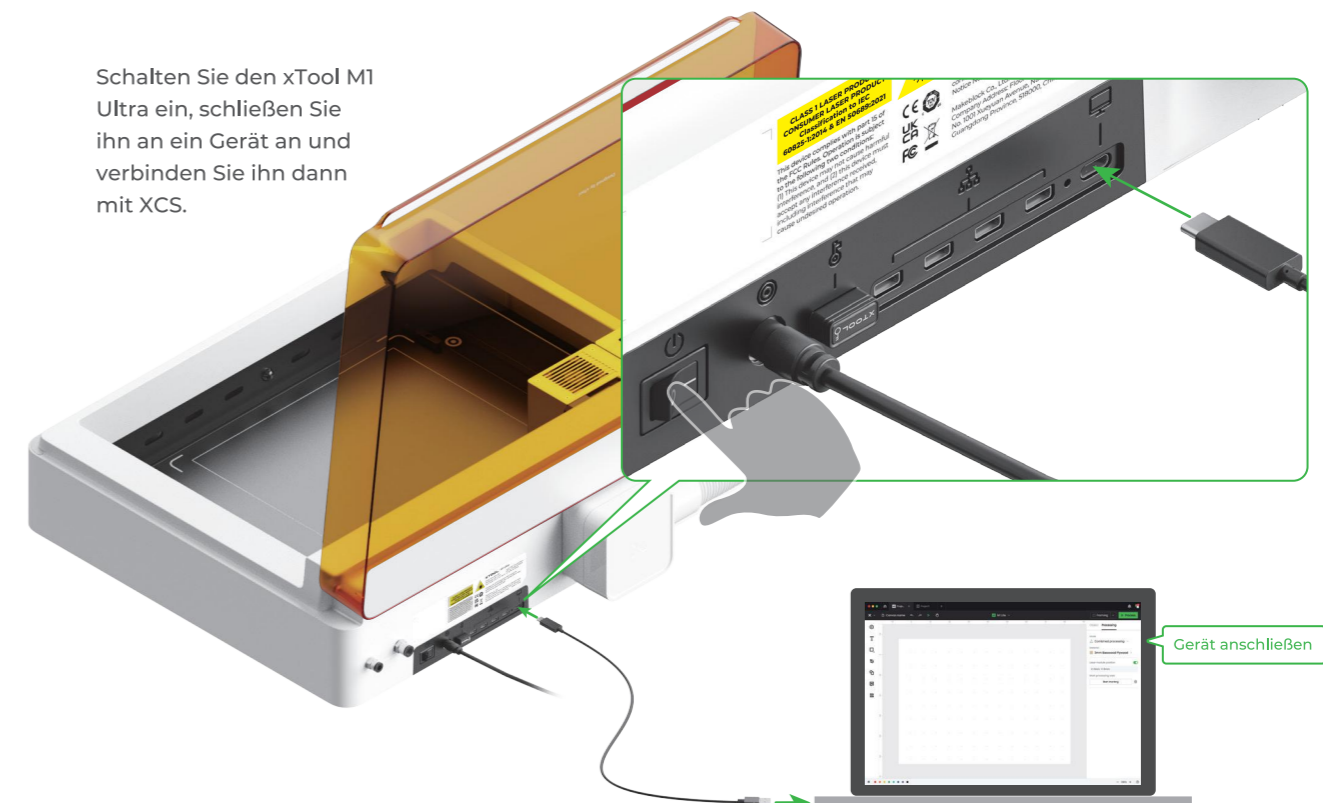

Um weitere Details zu erfahren, scannen Sie den folgenden QR-Code.



support@xtool.com

xTool M1 Ultra verwenden

Für das Schneiden mit dem Laser

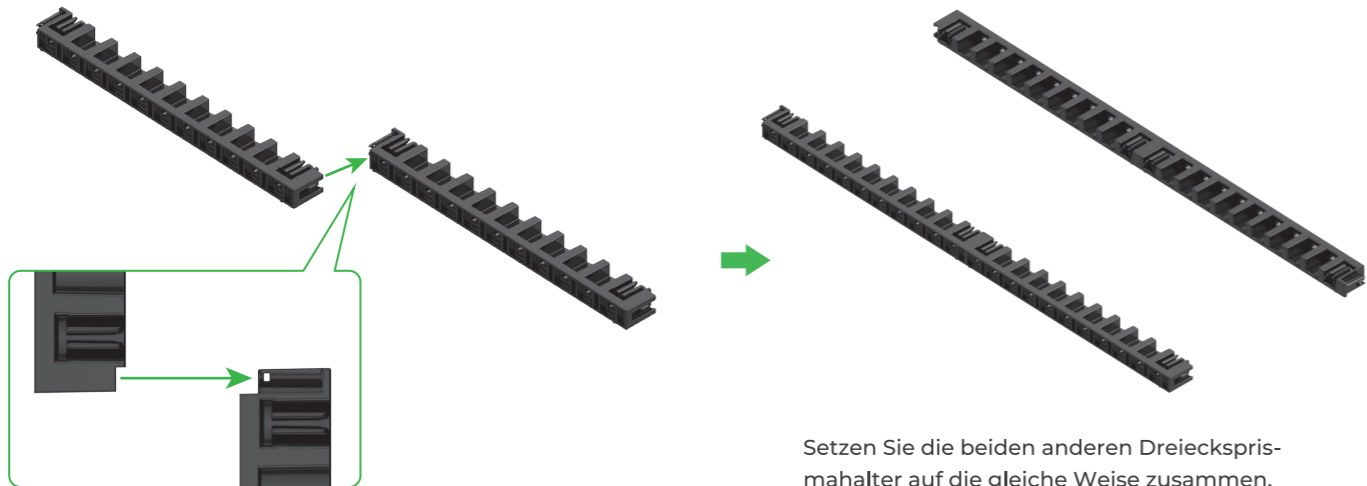
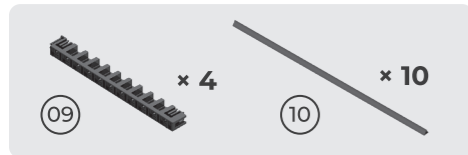

Setzen Sie die beiden anderen Dreiecksprismenhalter auf die gleiche Weise zusammen.

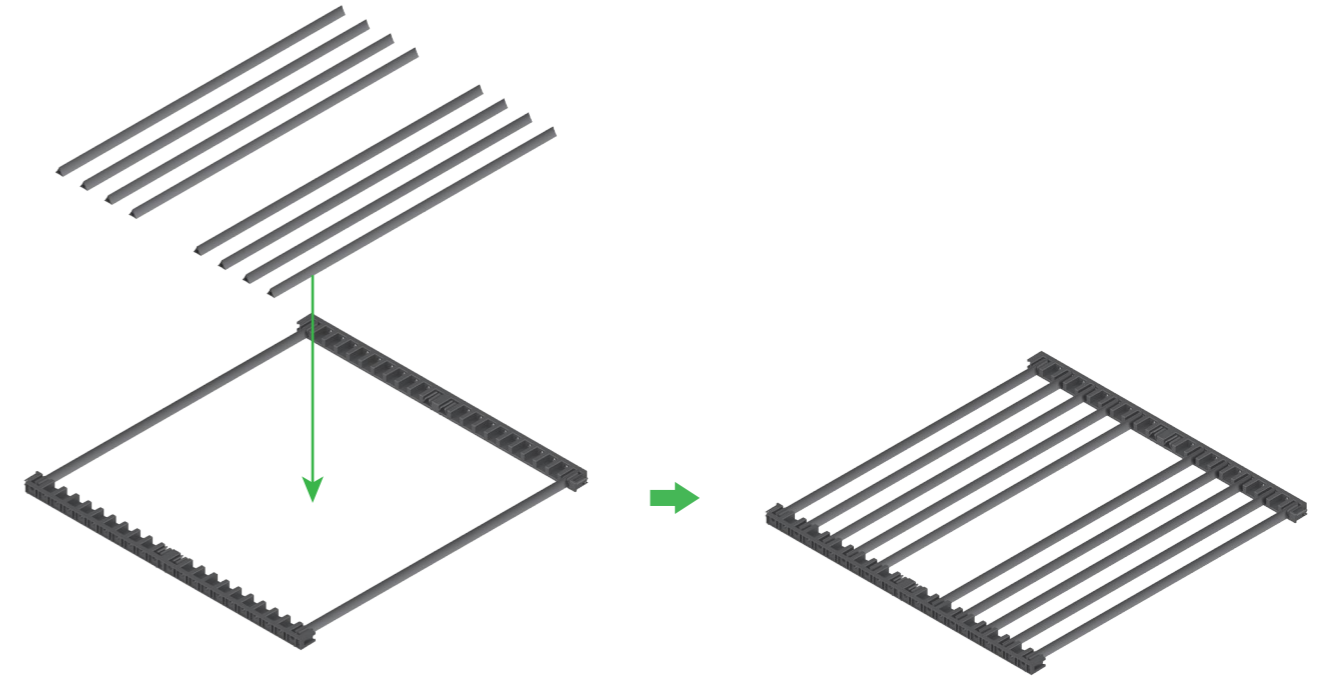
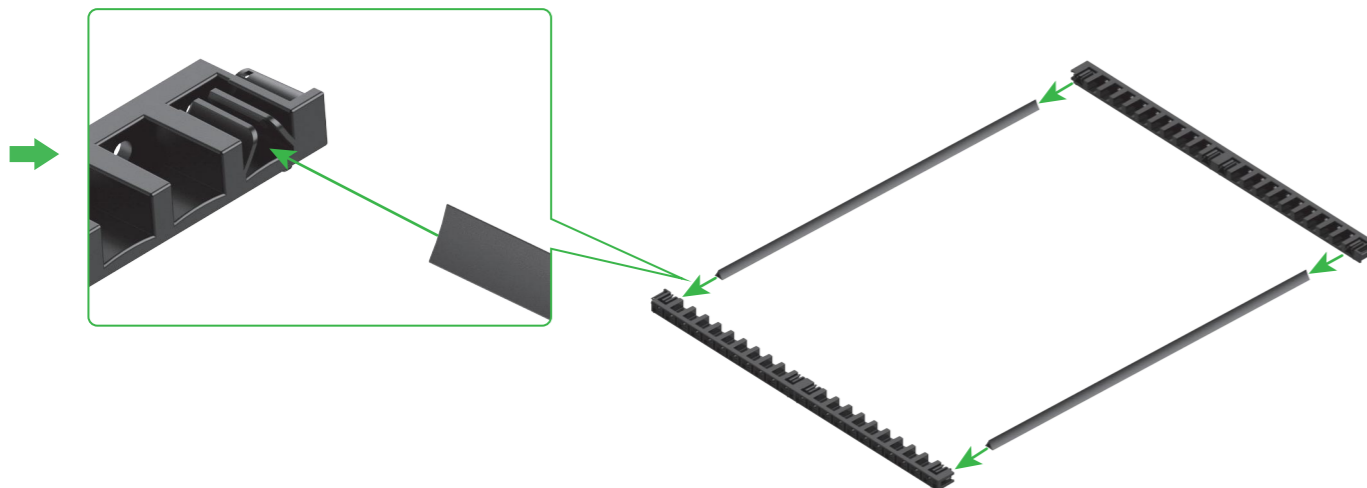

Bestimmen Sie die Anzahl der Dreiecksprismen anhand des zu bearbeitenden Materials.

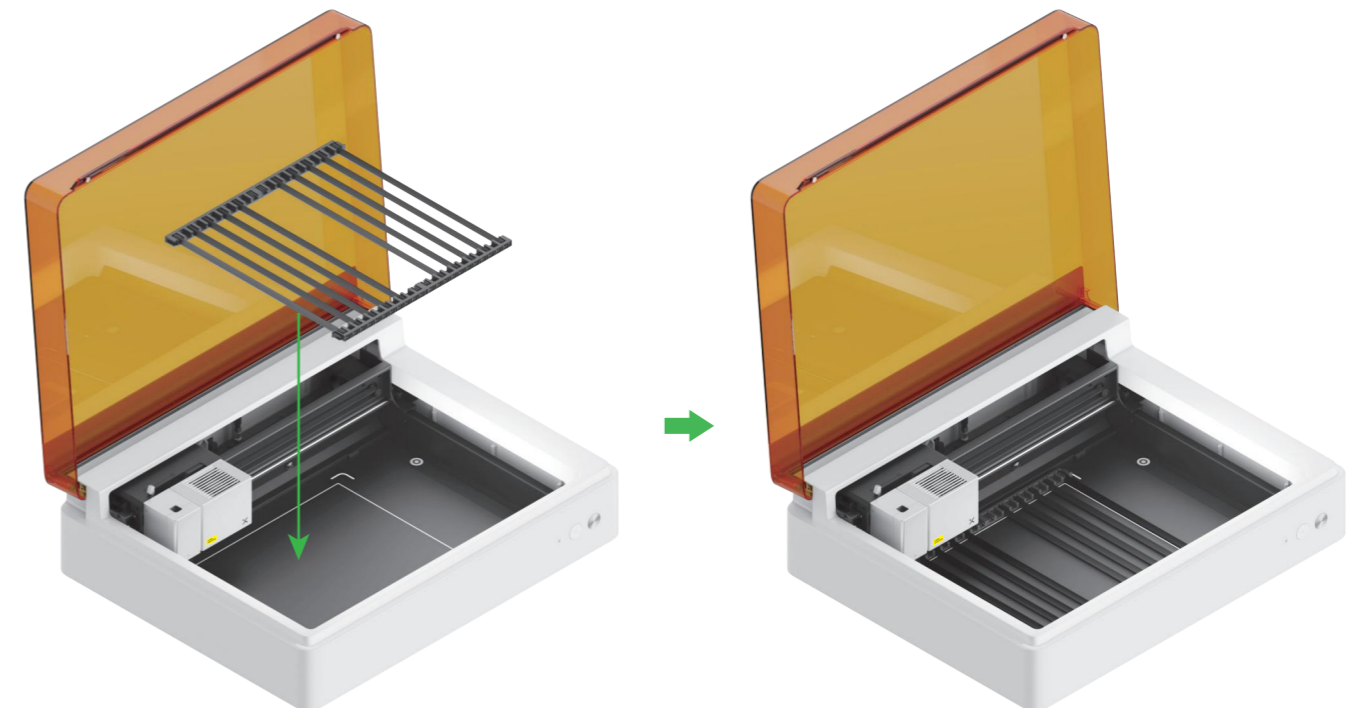

Für das Schneiden mit dem Messer oder eine Kombination aus Laserbearbeitung und Schneiden mit dem Messer

1

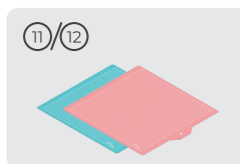

Hinweis: Für Papiermaterialien wie Karton und Kraftpapier verwenden Sie die Schneidematte LightGrip, für Gewebematerialien wie ein Tuch verwenden Sie die Schneidematte FabricGrip. Verwenden Sie keine Schneidematte, wenn Sie ein Material mit Laserstrahlen schneiden.

Schneidematte		
Farbe	Blau	Pink
Anwendbar bei	Leichten Materialien	Gewebe
Material	Karton, Packpapier, Druckerpapier Kraftpapier, Perlmutterpapier	Gewebe

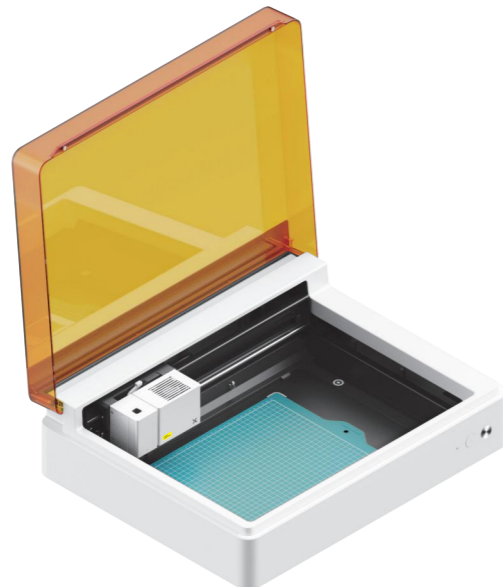
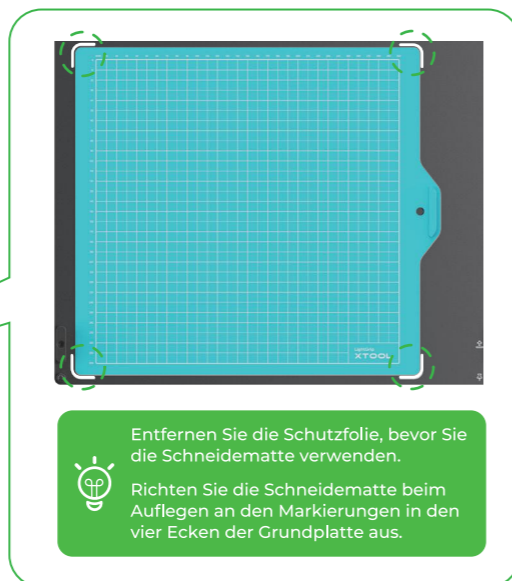
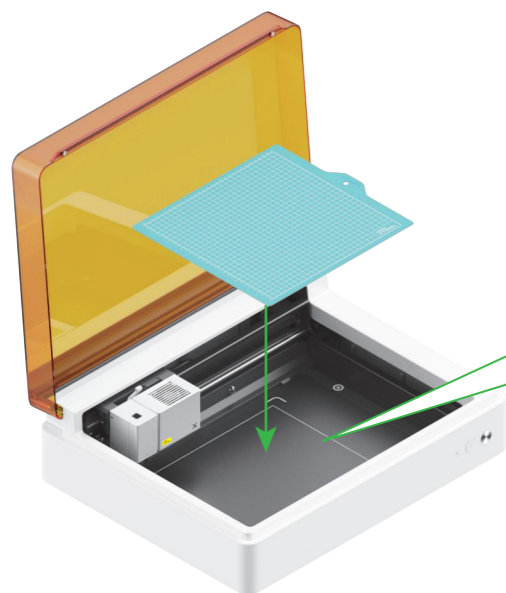

2

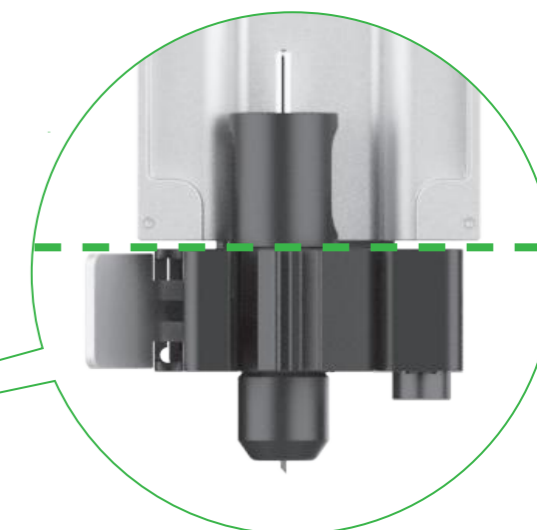
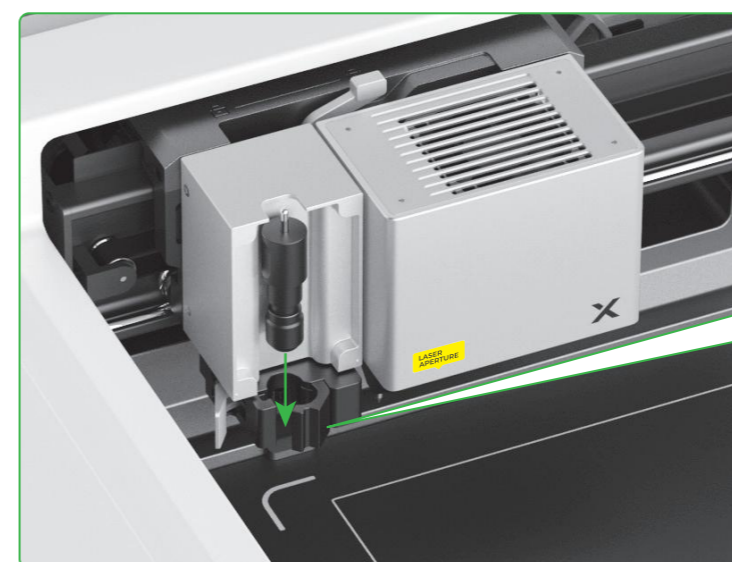
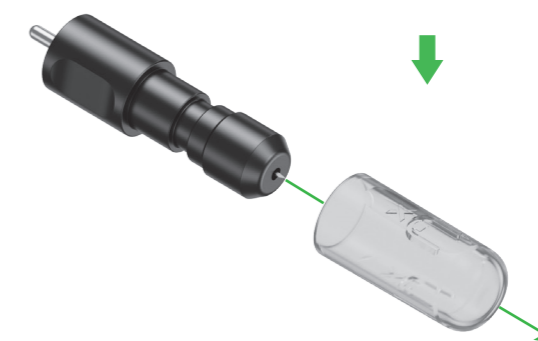
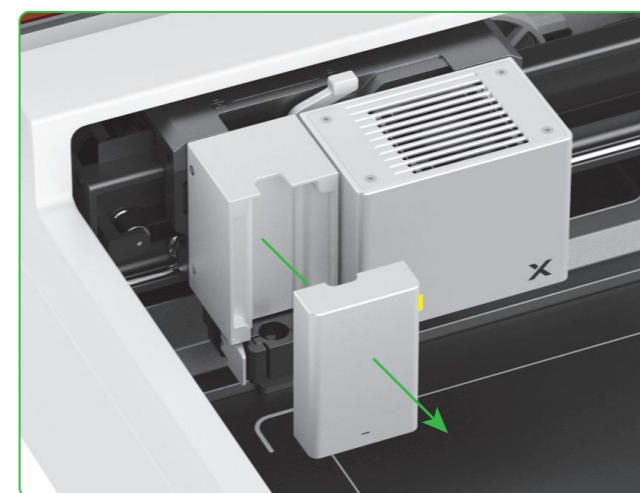

Vorsicht!
Scharfe Klinge

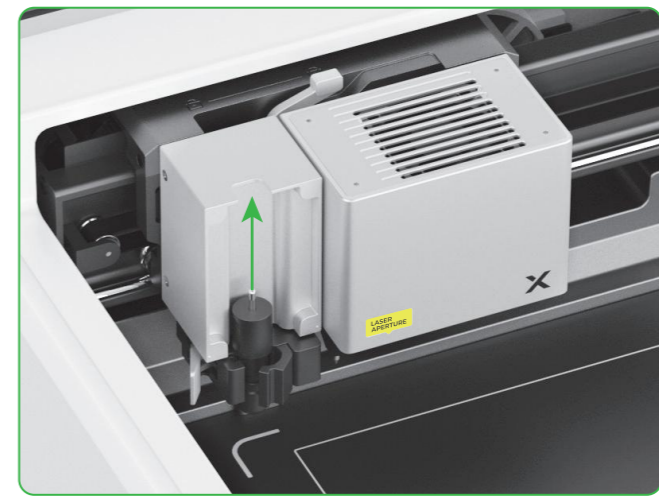
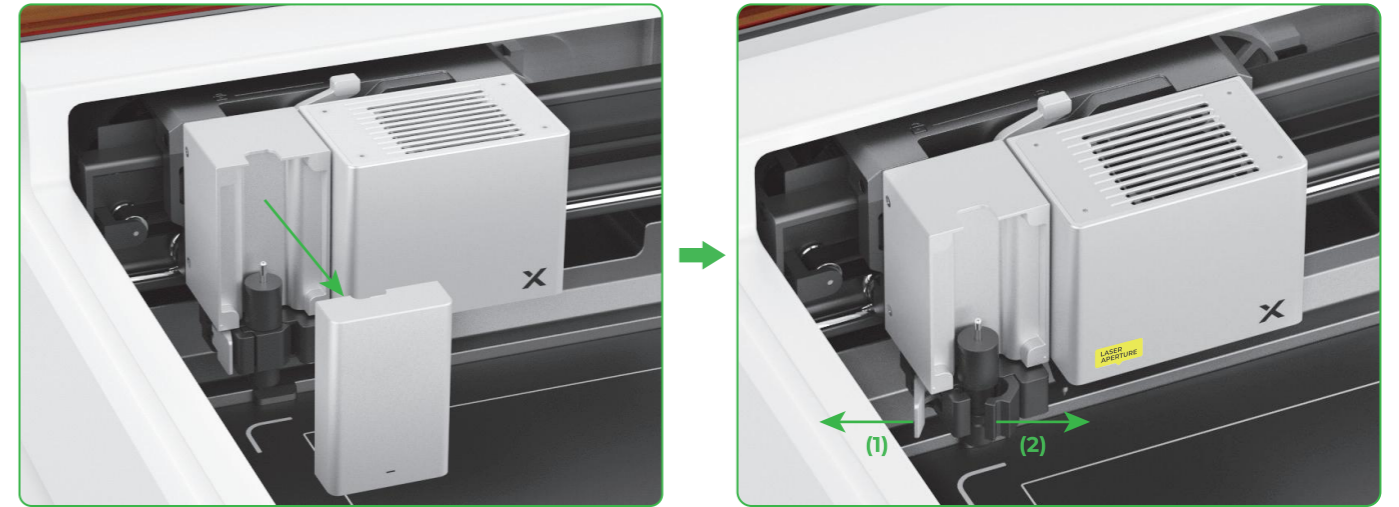
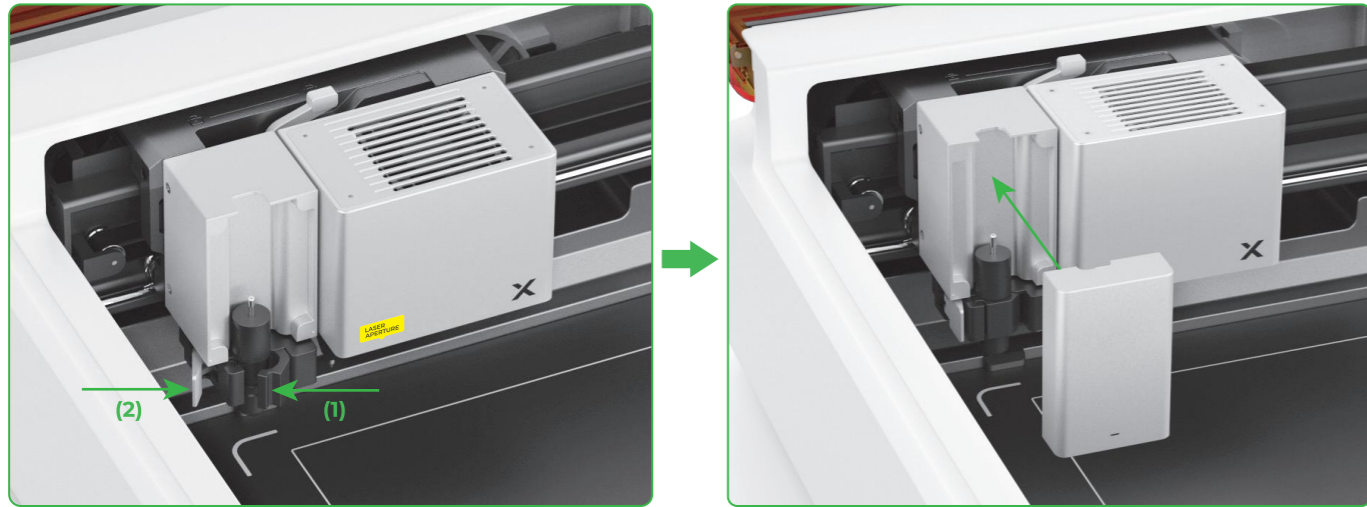

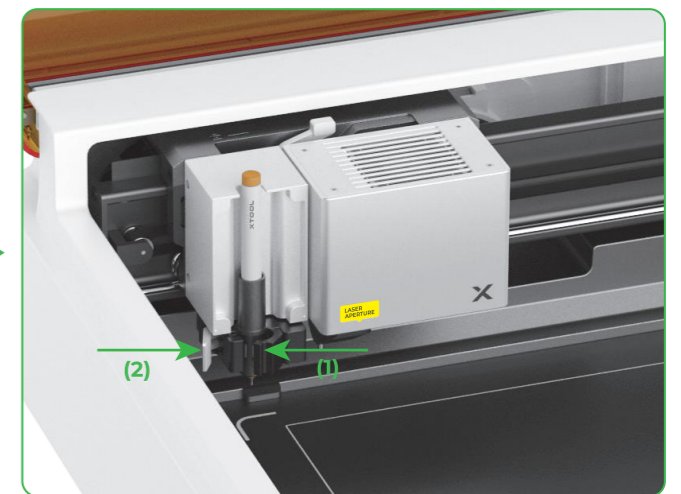
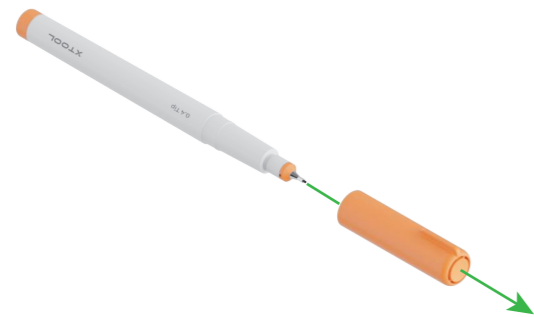

Vorsicht!
 Scharfe Klinge

Für das Zeichnen mit dem Stift

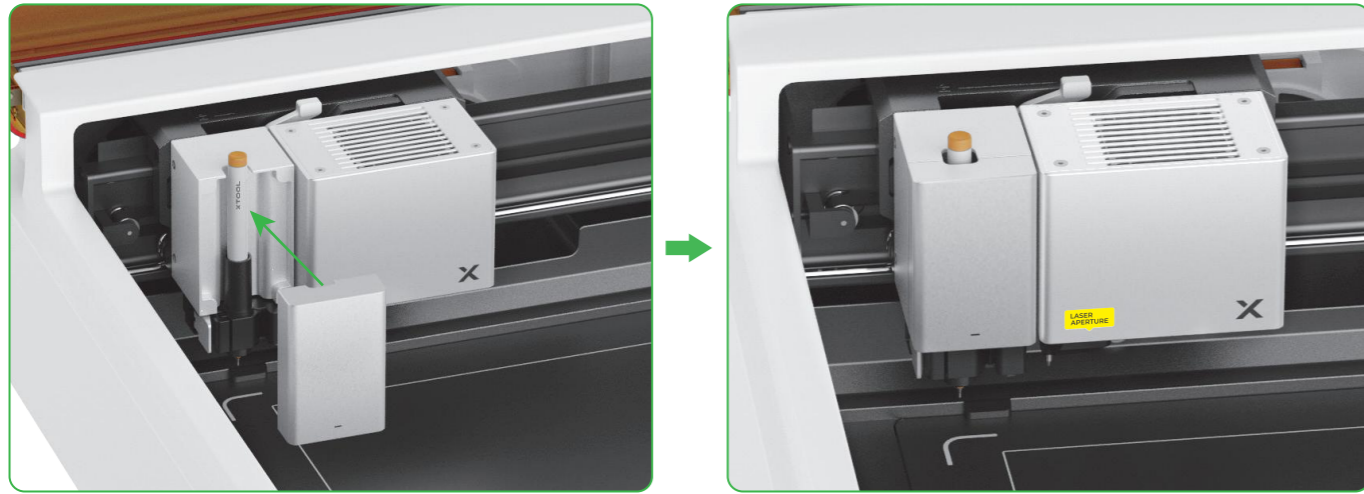

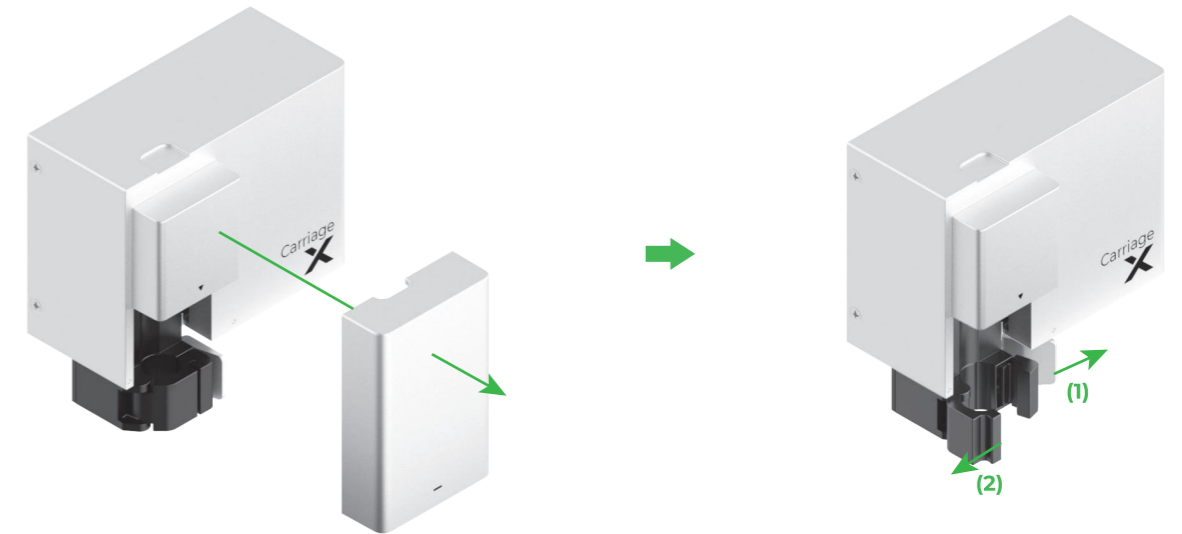
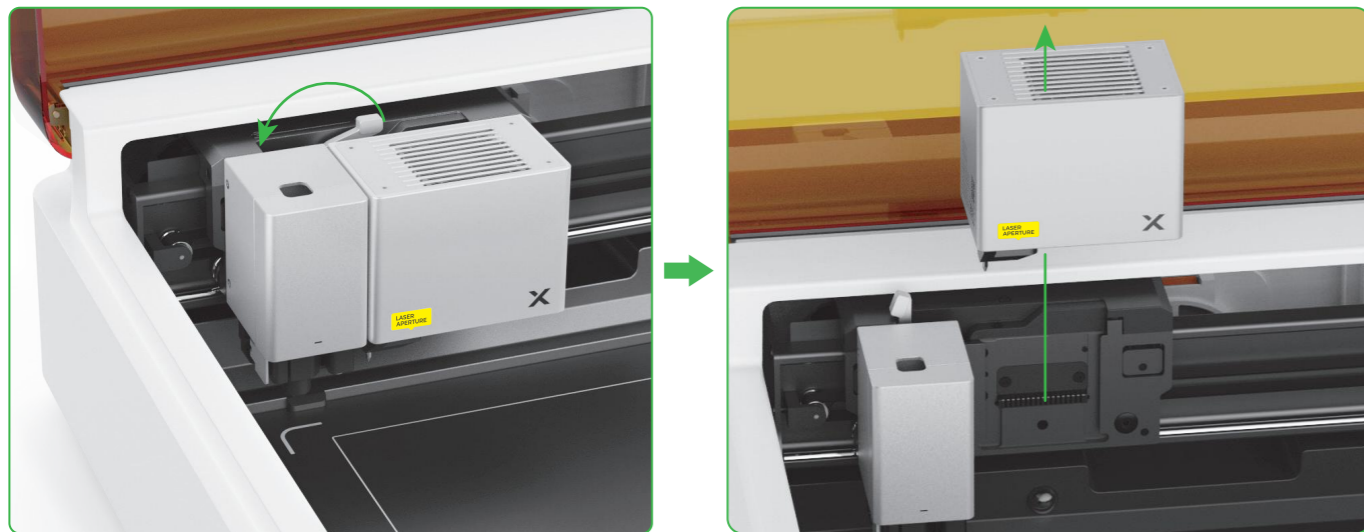
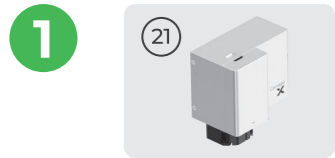

Für weitere Funktionen



2 Wählen Sie das Zubehör gemäß den Bearbeitungsanforderungen aus.

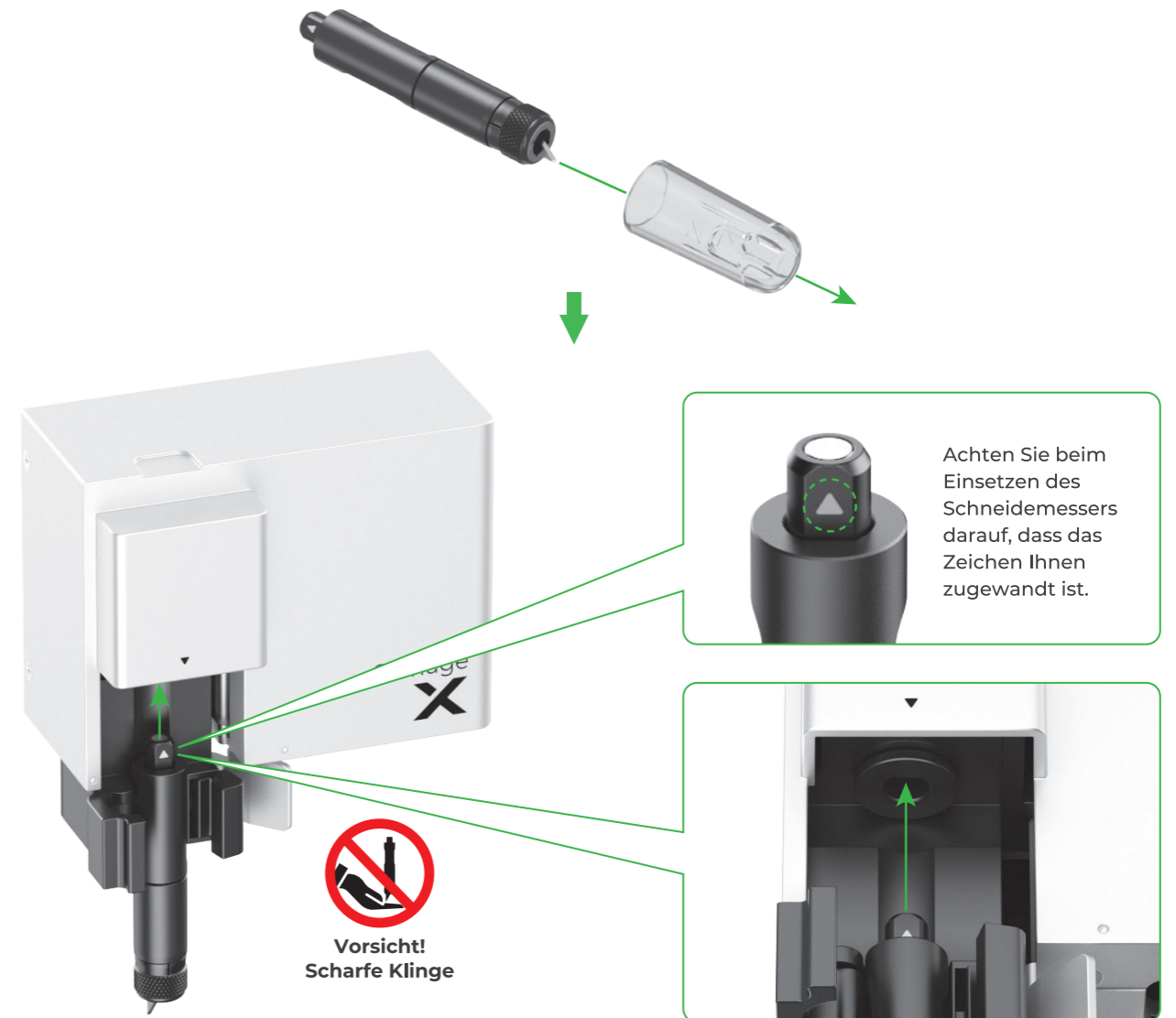

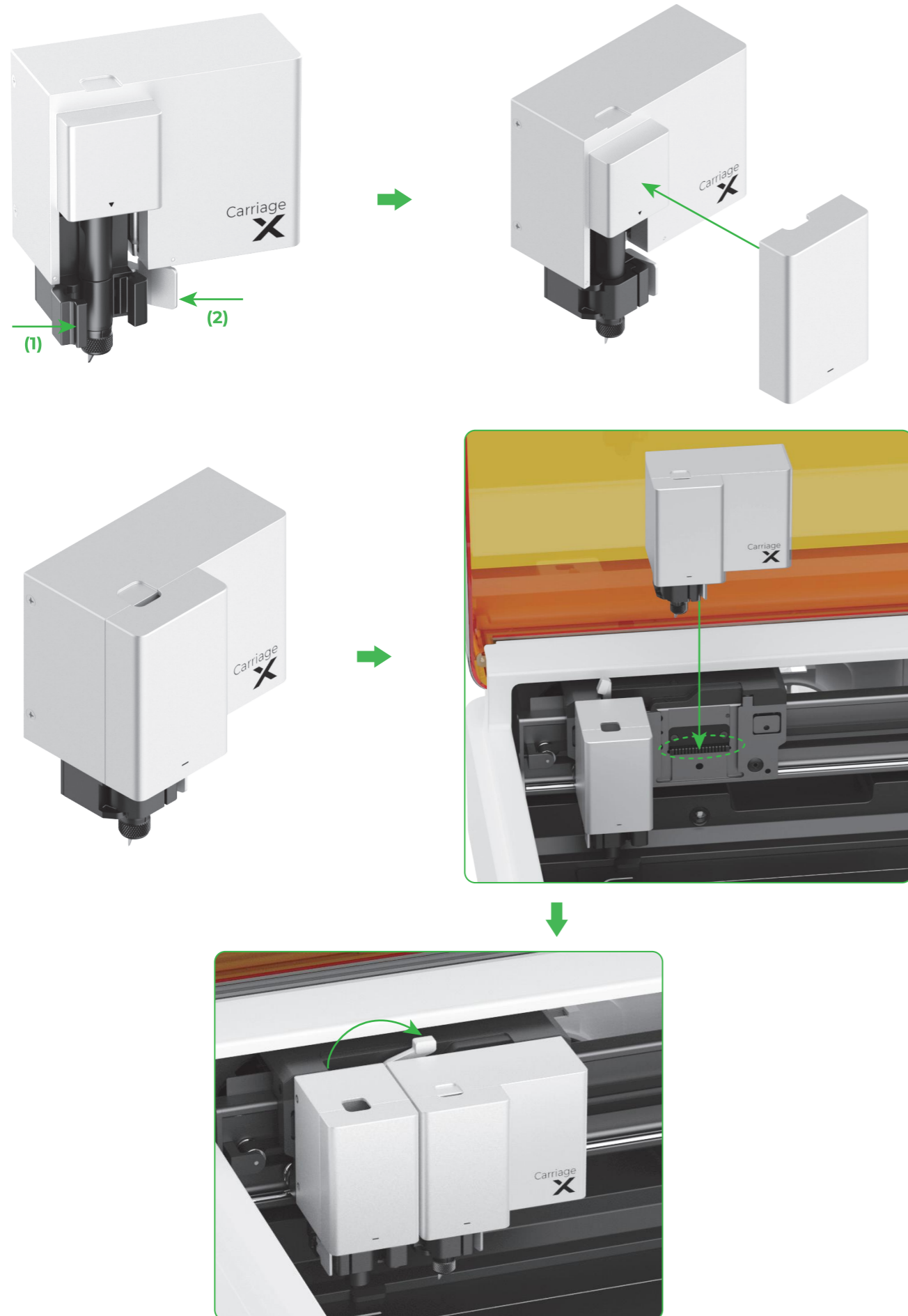

Beschreibung der Kontrollleuchte

Anzeigenstatus	Alarmton	Maschinenzustand
○ Leuchtet weiß	/	Standby, nicht mit XCS verbunden (im AP-Modus)
○ Einfarbig hellblau	/	Standby, nicht mit XCS verbunden (im STA-Modus)
○ Leuchtet violett	Ertönt einmal	Standby, mit XCS verbunden
○ Pulsiert weiß	/	Ruhezustand, nicht mit XCS verbunden
○ Pulsiert violett	/	Ruhezustand, mit XCS verbunden
○ Blinkt langsam violett	/	Firmware wird aktualisiert
○ Leuchtet grün	/	Markierung des Bearbeitungsbereichs auf XCS/Einrahmung/Bearbeitung
○ Blinkt langsam blau	Ertönt einmal	Bereit für Einrahmung/Bereit für Bearbeitung
○ Leuchtet blau	/	Aufgabe pausiert
○ Blinkt gelb	Ertönt einmal	Der Deckel ist während des Betriebs offen oder nicht vollständig geschlossen.
○ Blinkt gelb	Ertönt weiterhin	Flamme erkannt (kleine Flamme) /Gerät wackelt
○ Blinkt rot	Ertönt weiterhin	Flamme erkannt (große Flamme)
○ Blinkt gelb	Ertönt dreimal	Ausnahmen sind aufgetreten
○ Blinkt rot	Ertönt dreimal	Große Ausnahmen sind aufgetreten

Wartung

Filter ersetzen

13



Verwenden Sie den Filter nicht, wenn er feucht ist.

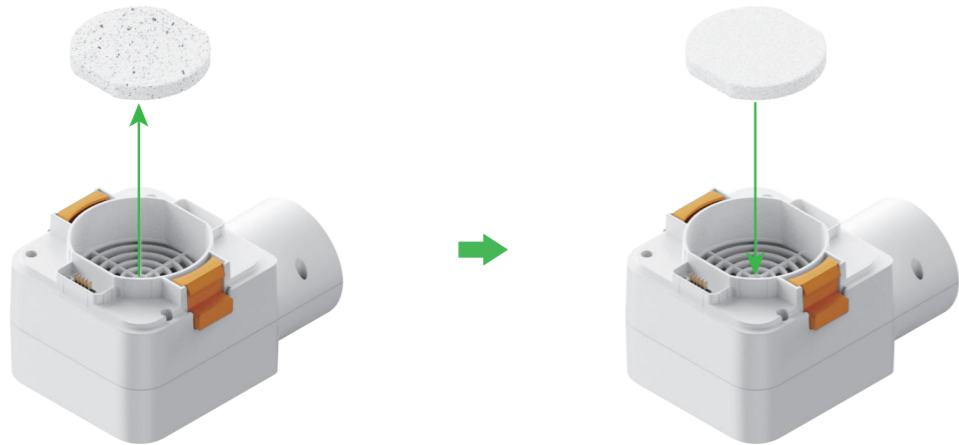

Linsenhalter ersetzen

18

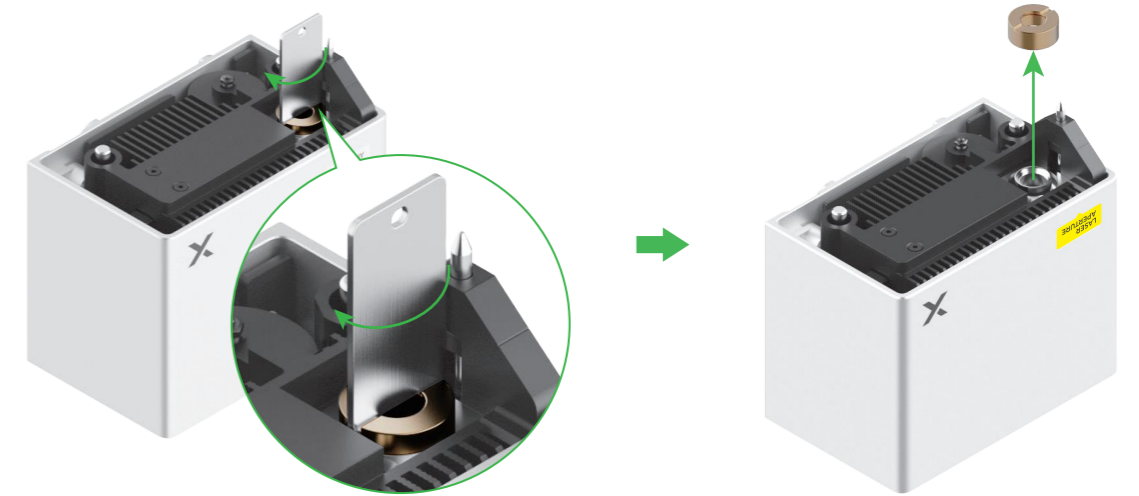
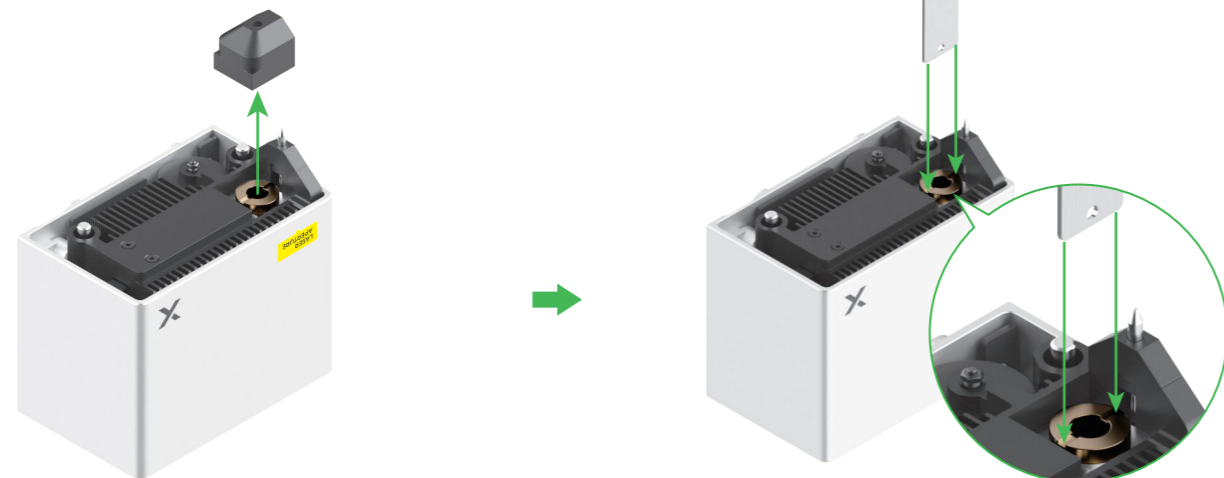
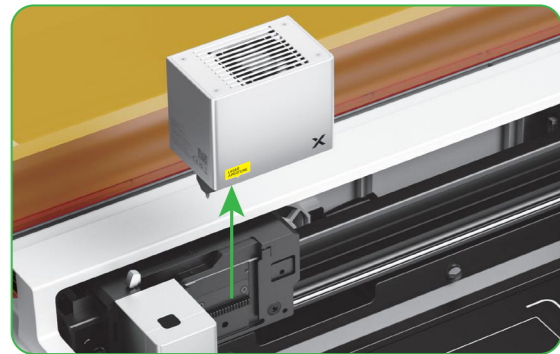

17

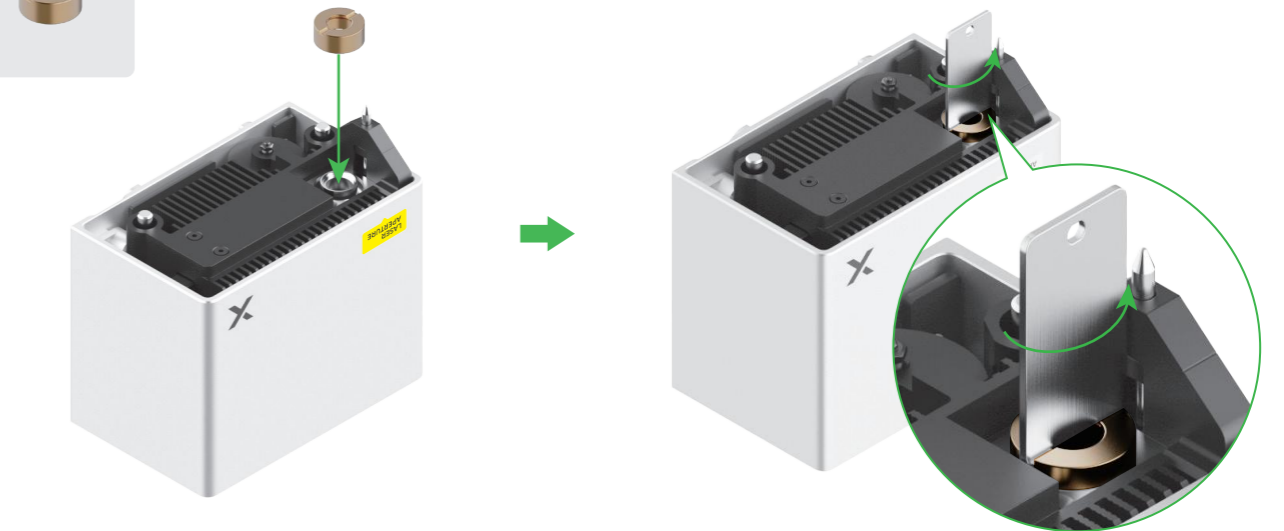

Sonde reinigen

Nach längerer Laserbearbeitung kann die Sonde allmählich verschmutzen. Reinigen Sie sie rechtzeitig, da die Genauigkeit der Brennweiteinstellung sonst abnehmen kann. Sie sollten die Sonde mit einem fusselfreien Tuch reinigen, das mit Alkohol angefeuchtet wurde.

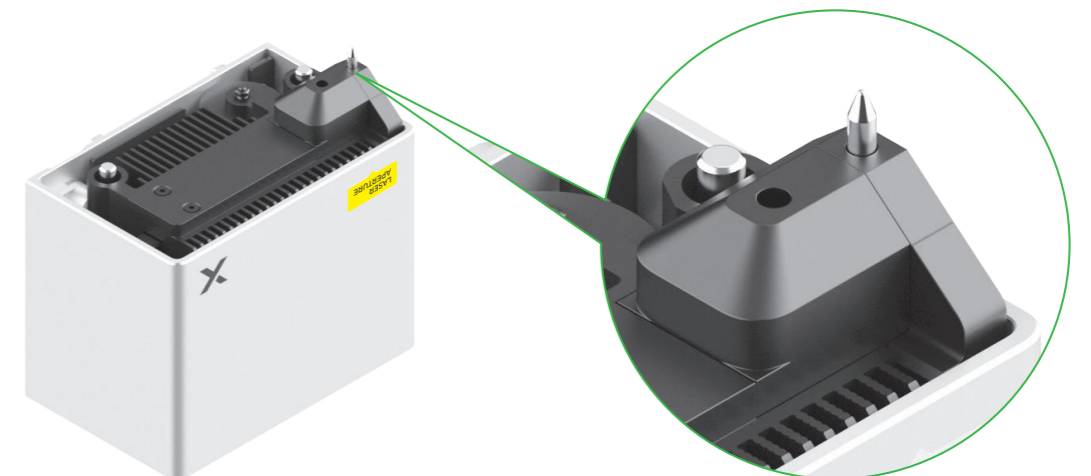

Häufig gestellte Fragen

1. Das Abgasmodul funktioniert während der Materialbearbeitung nicht. Was kann ich tun?

Mögliche Ursachen:

Am Absauggebläse hat sich zu viel Staub angesammelt.
/Der Filter ist blockiert.

Lösungen:

- (1) Schalten Sie den xTool M1 Ultra ab und bauen Sie das Abgasmodul aus.
- (2) Ersetzen Sie den Filter.
- (3) Bauen Sie das Abgasmodul wieder in den xTool M1 Ultra ein.

2. Das Lasermodul/der Multifunktionsträger funktioniert nicht ordnungsgemäß. Warum?

Mögliche Ursachen:

- Das Lasermodul/der Multifunktionsträger ist nicht ordnungsgemäß eingebaut.
- Die Verriegelungsstange über dem Lasermodul ist nicht eingerastet.

Lösungen:

- Drücken Sie das Lasermodul/den Multifunktionsträger nach unten, bis sie hörbar einrasten.
- Nachdem das Lasermodul oder der Multifunktionsträger eingesetzt wurde, schwenken Sie die Verriegelungsstange nach rechts, um sie zu verriegeln.

3. Die Sockelplatte oder die Schneidematte ist wegen langer Bearbeitungsdauer verschmutzt. Was kann ich tun?

- Reinigen Sie die Sockelplatte oder das Dreiecksprisma nach jeder abgeschlossenen Bearbeitung mit einem Reinigungstuch, das Sie zuvor mit Wasser angefeuchtet haben, und trocknen Sie die Platte oder das Prisma anschließend ab.
- Falls die Sockelplatte stark verschmutzt und schwer zu reinigen ist, reinigen Sie sie mit einem Reinigungstuch, das Sie zuvor mit reinem Äthylalkohol angefeuchtet haben.

4. Wann muss ich den Filter ersetzen?

Die Häufigkeit hängt vom Material ab. Sie müssen den Filter in folgenden Fällen ersetzen:

- Am XCS wird eine Meldung eingeblendet, dass Sie den Filter ersetzen müssen.
- Im Geräteinneren hat sich viel Rauch angesammelt.

5. Wenn ich einen orangefarbenen Stift für die Bearbeitung verwende, kann ich die vom Stift gezeichneten Linien nicht sehen. Warum?

Weil der Deckel orange ist.

Konformitätserklärung

Hiermit erklärt Makeblock Co., Ltd., dass dieses Produkt die grundlegenden Anforderungen und anderen relevanten Vorschriften der Richtlinie RED 2014/53/EU und der RoHS-Richtlinie 2011/65/EU einhält.

Kundendienst

Für technische Unterstützung kontaktieren Sie uns bitte unter support@xtool.com.
Weitere Informationen über Kundendienstleistungen finden Sie unter support.xtool.com.

ES

Informe	50
Primero la seguridad (importante)	50
Lista de elementos	52
Conozca su xTool M1 Ultra	54
Preparación	56
Utilice xTool M1 Ultra	60
Descripción del indicador	69
Mantenimiento	70
Preguntas frecuentes	72
Declaración de conformidad	72
Servicio de posventa	72

Informe

¡Bienvenido al uso de los productos xTool!

Si está utilizando este producto por primera vez, lea cuidadosamente todo el material que lo acompaña para mejorar la experiencia con el producto. Si no utiliza este producto de acuerdo con las instrucciones y requisitos del Manual u opera el producto de manera errónea, etc., la empresa no se hará responsable de ningún daño.

La empresa ha cotejado el contenido del manual de manera rigurosa; sin embargo, pueden llegar a quedar algunos errores u omisiones.

La empresa se compromete a seguir mejorando las funciones de sus productos y la calidad de sus servicios y, por lo tanto, se reserva el derecho de cambiar cualquier producto o software descrito en el Manual, así como también el contenido del Manual en cualquier momento.

La función de este Manual es la de ayudarlo a utilizar este producto de manera apropiada y no incluye ninguna descripción de la configuración del hardware o software. Para ver la configuración del producto, revise el contrato relacionado (si existe) y la lista de embalaje, o consulte al distribuidor. Las imágenes en el Manual son únicamente de referencia y pueden variar con respecto al producto real.

El manual está protegido por las leyes y reglamentos sobre derechos de autor y no podrá reproducirse ni transcribirse en ningún modo, ni transmitirse por ninguna red alámbrica o inalámbrica de ninguna forma, ni traducirse a ningún idioma, ni modificarse en modo alguno en su contenido, imagen o maquetación, sin la autorización previa por escrito de la empresa.

La empresa se compromete a mejorar de forma continua el producto y los materiales relacionados. El producto y el manual están sujetos a modificaciones, y las actualizaciones están disponibles en xtool.com.

Primero la seguridad (importante)

1. Seguridad general

Lea y familiarícese con todos los procedimientos y precauciones de seguridad antes de utilizar la máquina. Los usuarios deben seguir todas las precauciones de seguridad en forma estricta y asegurarse de que el xTool M1 Ultra esté ensamblado adecuadamente.

Precaución

Cumpla con los siguientes principios de funcionamiento:

- Revise que la xTool M1 Ultra no tengan daños en todo momento antes de su uso. Evite utilizar una xTool M1 Ultra dañada o defectuosa de forma alguna.
- Conserve el área de trabajo limpia y plana.
- Si no está autorizado, evite desarmar o cambiar la estructura

de la xTool M1 Ultra en forma alguna. Así mismo, evite modificar o descompilar el sistema operativo de la xTool M1 Ultra por cuenta propia.

- No deje la máquina sin supervisión mientras está en funcionamiento. Preste atención si está funcionando adecuadamente.
- Conserve limpia la parte interna de la xTool M1 Ultra. Los residuos y astillas acumulados durante el corte y grabado son peligrosos y pueden ocasionar un incendio. Limpie regularmente las virutas y los residuos del interior del área de trabajo.
- La temperatura de funcionamiento del láser es de 0°C y 35°C, la temperatura de almacenamiento es -10°C y 40°C. Se prohíbe estrictamente el funcionamiento por debajo de 0°C.
- Este producto no es reparable por el usuario. Debe ser devuelto a la fábrica o reparado por profesionales autorizados.

2. Seguridad del sistema láser

Por lo general, durante la operación el módulo láser está totalmente aislado dentro de la carcasa y el protector de luz. La xTool M1 Ultra cuenta con un interruptor de bloqueo de seguridad. Si se levanta la tapa durante el funcionamiento, la xTool M1 Ultra dejará de funcionar.

Advertencia

Cumpla con los siguientes lineamientos de seguridad:

- Recuerde que la falta de cualquier pieza de la xTool M1 Ultra puede exponer el sistema láser y aumentar el riesgo de daño al equipo.
- Evite grabar o cortar cualquier material que contenga PVC o vinilo (no se recomienda los plásticos procesados). Estos materiales (y otros que contienen cloro/cloruro) pueden generar vapor corrosivo extremadamente dañino para el cuerpo humano y puede ocasionar daños a la xTool M1 Ultra. La garantía de la empresa no cubre daños ocasionados por grabar o cortar materiales que contengan PVC o vinilo.
- Evite grabar o cortar material desconocido. La vaporización/fundición de muchos materiales, incluso PVC y policarbonato, entre otros, liberará humo dañino.
- La operación con láser está prohibida cuando la tapa está levantada. Asegúrese de que la xTool M1 Ultra está cerrado por la tapa durante el funcionamiento y no manipule el mecanismo de seguridad de la tapa.
- No deje la máquina sin supervisión mientras está en funcionamiento. Preste atención si está funcionando adecuadamente.

Las normas de referencia para la seguridad láser son la American National Standard for Safe Use of Lasers (Z136.1-2022), la International Electrotechnical Commission Standard (IEC 60825-1:2014) y las normas europeas (EN 60825-1:2014/A11:2021 y EN 50689:2021).

3. Seguridad contra incendios



El xTool M1 Ultra utiliza un rayo láser de alta densidad para irradiar el material que desee cortar o grabar, de modo que calienta la superficie del material y vaporiza el material sin quemarlo. Sin embargo, la mayoría de materiales son inflamables por naturaleza y pueden prenderse para formar una llama expuesta que puede incendiar la xTool M1 Ultra (incluso si está fabricado con materiales con retardante de llamas) y su entorno. La experiencia demuestra que es muy probable que el corte de vectores con un láser produzca una llama expuesta.

Peligro

Lea minuciosamente las siguientes advertencias y recomendaciones:

- Equipos para uso en lugares donde no es probable que haya niños.
- Asegúrese de que el lugar de trabajo esté bien ventilado para que el humo generado pueda evacuarse a tiempo.
- Recuerde que los materiales apilados (especialmente materiales orgánicos, como el papel) pueden provocar la propagación de llamas o aumentar el riesgo de ignición de materiales. (especialmente el extremo del tubo de escape de humos)
- Evite abandonar la xTool M1 Ultra durante su funcionamiento. Existe un riesgo de incendio si la xTool M1 Ultra comienza a funcionar debido a un ajuste incorrecto y la falta de supervisión durante periodos prolongados, o si la xTool M1 Ultra tiene una avería mecánica o eléctrica durante su funcionamiento.
- Limpie la xTool M1 Ultra frecuentemente. La acumulación excesiva de residuos y astillas debido al corte y grabado puede aumentar el riesgo de incendio. La zona de trabajo interna debe limpiarse periódicamente para garantizar que no queden residuos ni astillas en el interior del aparato.
- Conserve el área alrededor del xTool M1 Ultra limpia y libre de materiales inflamables amontonados, explosivos o solventes volátiles, como acetona, alcohol o gasolina.
- Proporcione extintores de incendio y realice mantenimiento e inspección de forma frecuente.
- Si se produce un incendio durante el proceso, póngase a salvo. En caso de pequeñas llamas, puede esperar a que se apaguen por sí solas. Ante incendios de mayor dimensión, mantenga la distancia de seguridad y utilice un extintor.
- Se recomienda utilizar el juego de seguridad contra incendios xTool al grabar o cortar materiales inflamables con el rayo láser para evitar incendios.

4. Seguridad de equipos eléctricos

Precaución

Lea minuciosamente las siguientes advertencias y recomendaciones y cúmplalas de forma estricta:

- Cuando la xTool M1 Ultra esté conectado a la fuente de alimentación, evite abrir el panel de acceso de la xTool M1 Ultra para evitar daños debidos al contacto accidental con la fuente de alimentación.
- Cuando la xTool M1 Ultra esté conectada a la fuente de

alimentación, evite tocar cualquier área con componentes electrónicos con las manos o con otras herramientas.

5. Mantenimiento

Precaución

Precaución - El uso de controles o ajustes o la realización de procedimientos distintos a los especificados en este manual pueden provocar una exposición peligrosa a la radiación. Lea atentamente las siguientes advertencias y sugerencias:

- Corte la alimentación eléctrica antes de realizar el mantenimiento del aparato.
- Evite el contacto de la cuchilla con los dedos al retirar el módulo láser o la cuchilla, o podría lesionarse.
- Las cuchillas están muy afiladas. Tenga cuidado de no hacerse daño en las manos al instalarlos o sustituirlos.
- Coloque las cuchillas usadas en un recipiente que pueda evitar que los objetos punzantes hieran a las personas, como una caja metálica, selle el recipiente y deséchelo.

6. Advertencias y señales de instrucción

Todos los signos de advertencia e información adjuntos a la máquina están ubicados en lugares que pueden ser una fuente de peligro antes y/o durante el funcionamiento. Las señales de advertencia e información dañadas o perdidas deben ser reemplazadas inmediatamente. Los signos de advertencia e información perdidos pueden ser replicados usando las plantillas de la siguiente página.

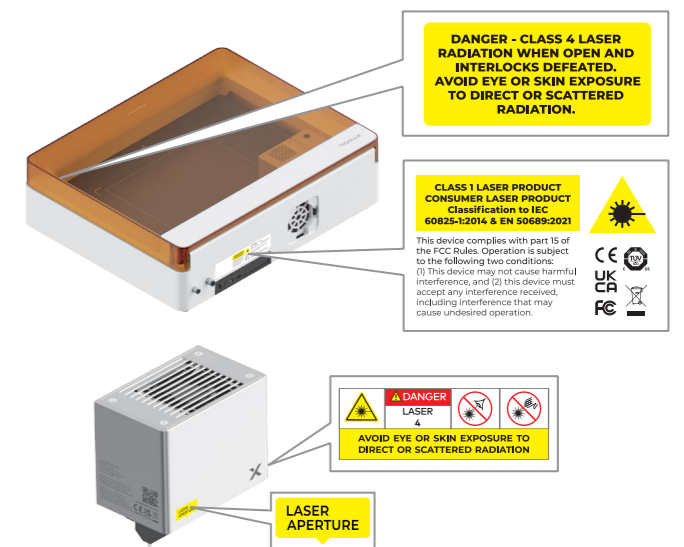

Potencia máxima de transmisión RF: Wi-Fi 2.4G (2412-2472 MHz) < 20 dBm

Especificaciones del láser

	Longitud de onda	Divergencia del haz	Potencia máxima de salida
Láser de trabajo	455±5nm	1.5mrad (IEC 60825-1 Default (simplified) evaluation C6=1)	20 W
Láser indicador	650±5nm	/	0.39 mW

Lista de elementos

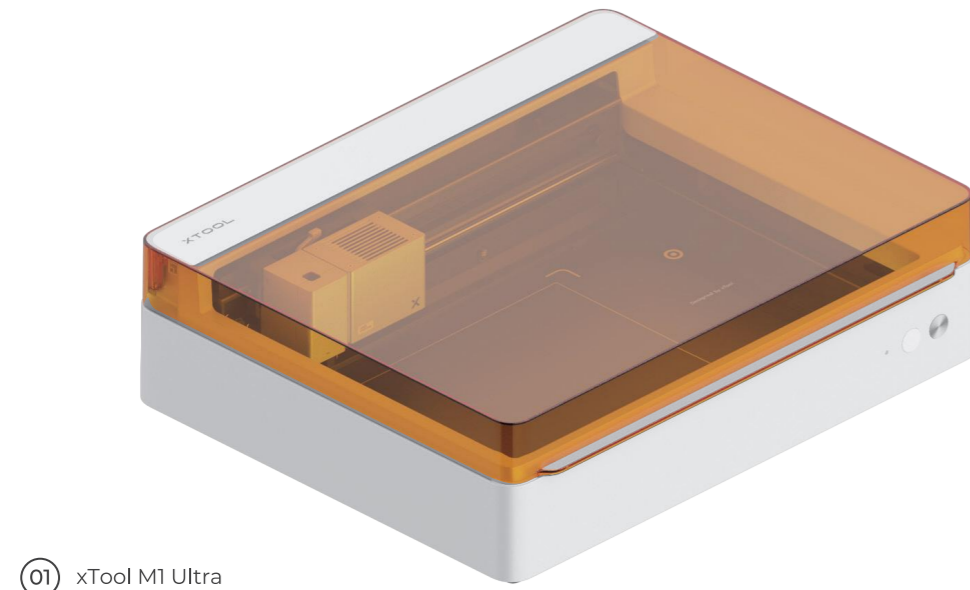

01 xTool M1 Ultra



02 Módulo láser

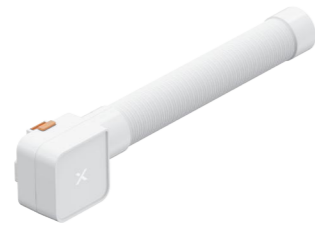

03 Módulo de escape de humo



04 Cable USB



05 Adaptador y cable



06 Hoja de punta fina



07 Bolígrafo de punta fina



08 Portabolígrafos

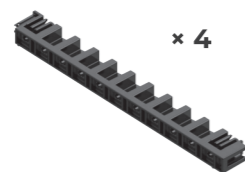

09 Soporte de prisma triangular

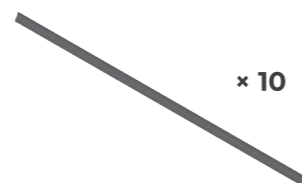

10 Prisma triangular

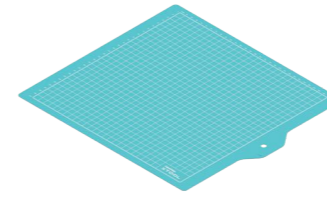

11 Alfombrilla de corte (LightGrip)

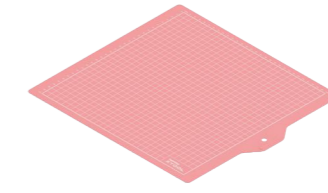

12 Alfombrilla de corte (FabricGrip)



13 Filtro



14 Llave



15 Aceite

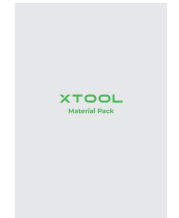

16 Paquete de material

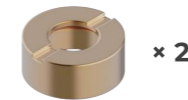

17 Montura del objetivo (repuesto)



18 Pieza giratoria de la montura del objetivo



19 Destornillador



20 Manual de usuario



21 Carro multifunción



22 Cuchilla corte

Conozca su xTool M1 Ultra

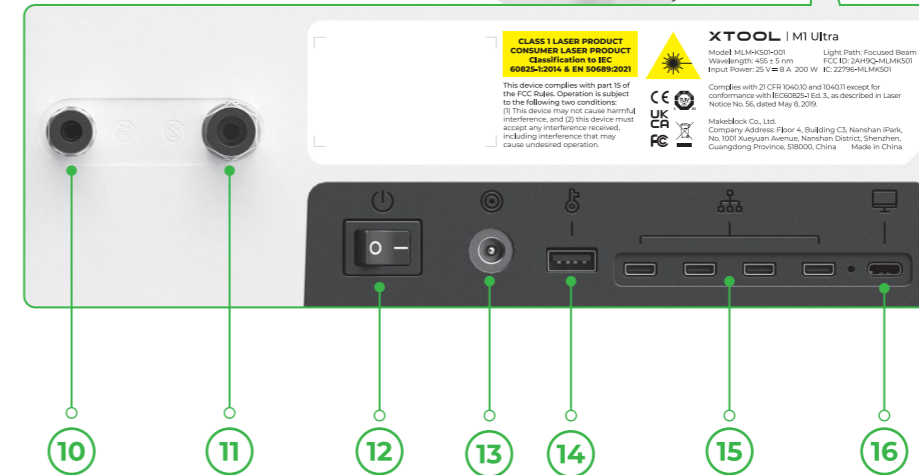
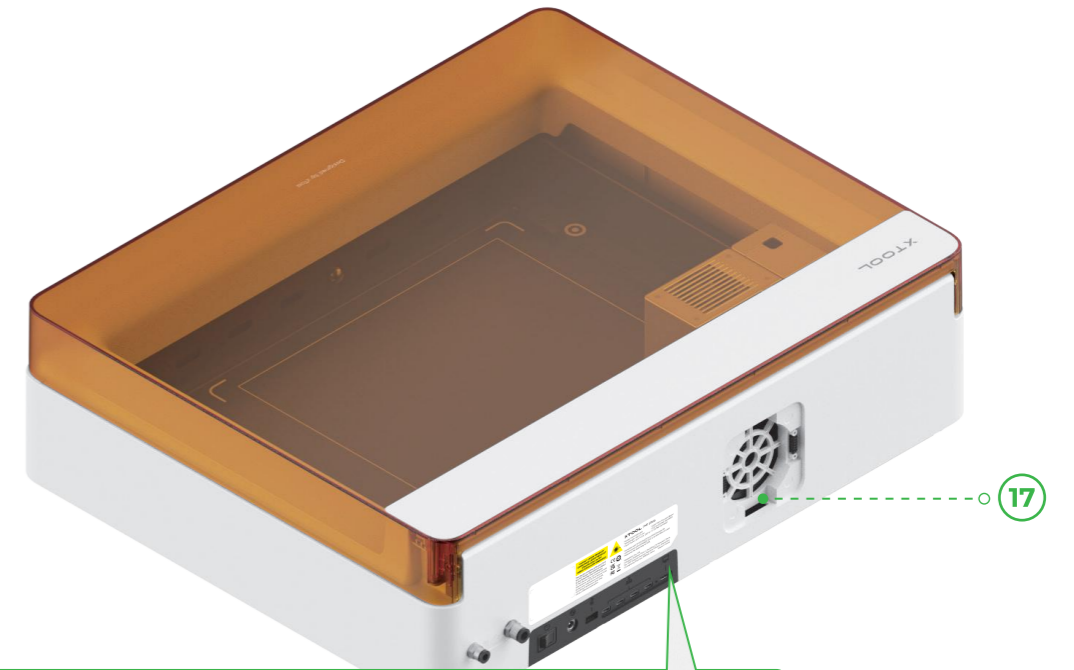
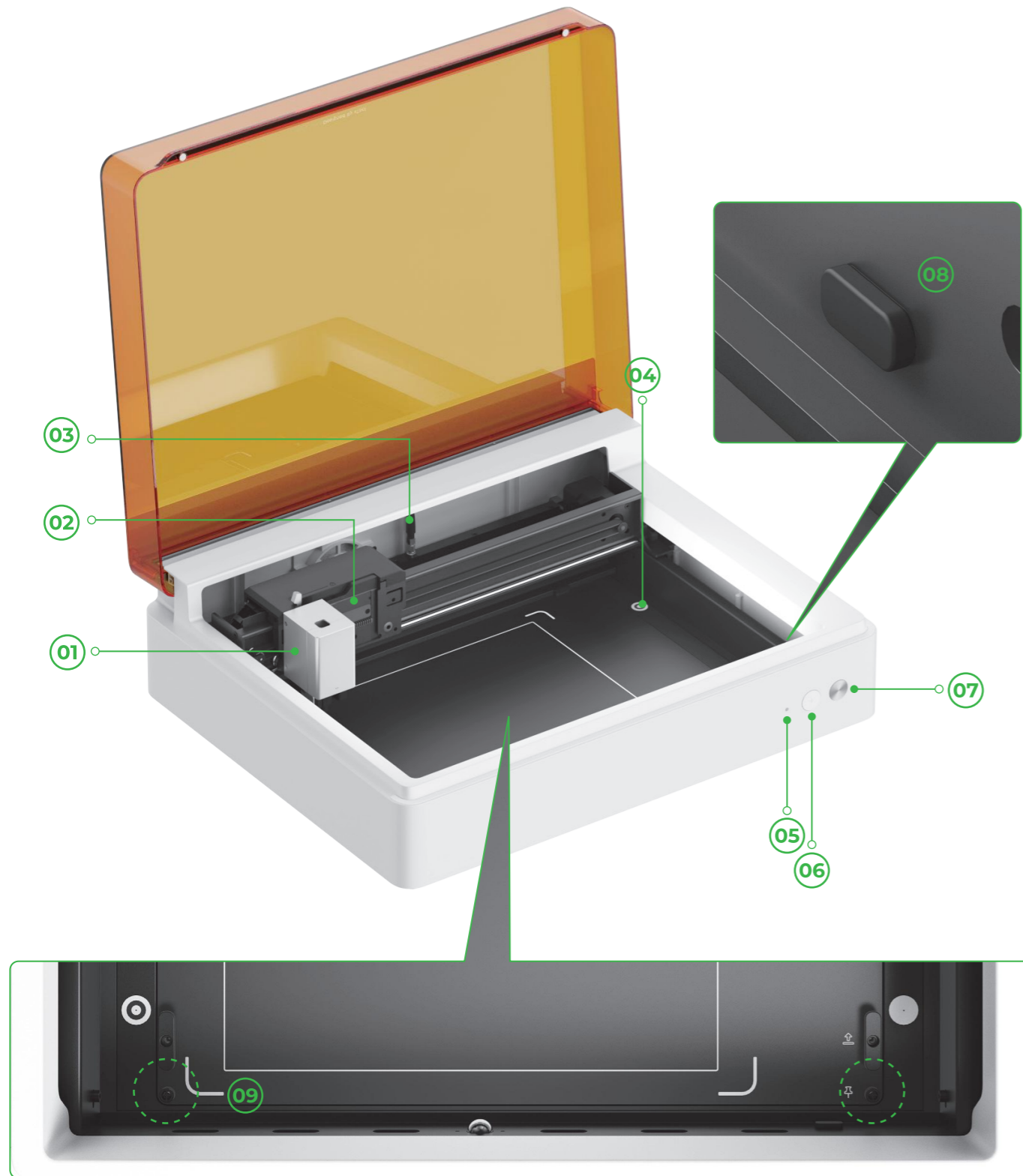

- | | | | | | |
|----|------------------------------|----|--|----|-------------------------|
| 01 | Carro básico | 07 | Botón de inicio/parada | 13 | Puerto de alimentación |
| 02 | Soporte multifunción | 08 | Puerto de módulo rotativo | 14 | Puerto para la llave |
| 03 | Antena wifi | 09 | Tornillo de mariposa para la placa base | 15 | Puerto de extensión × 4 |
| 04 | Punto del visor de la cámara | 10 | Racor para tubo para el set de asistencia de aire | 16 | Puerto USB |
| 05 | Indicador | 11 | Racor para tubo para el conjunto de seguridad contra incendios | 17 | Salida de humo |
| 06 | Botón de marcado de puntos | 12 | Interruptor de encendido | | |

Preparación

1

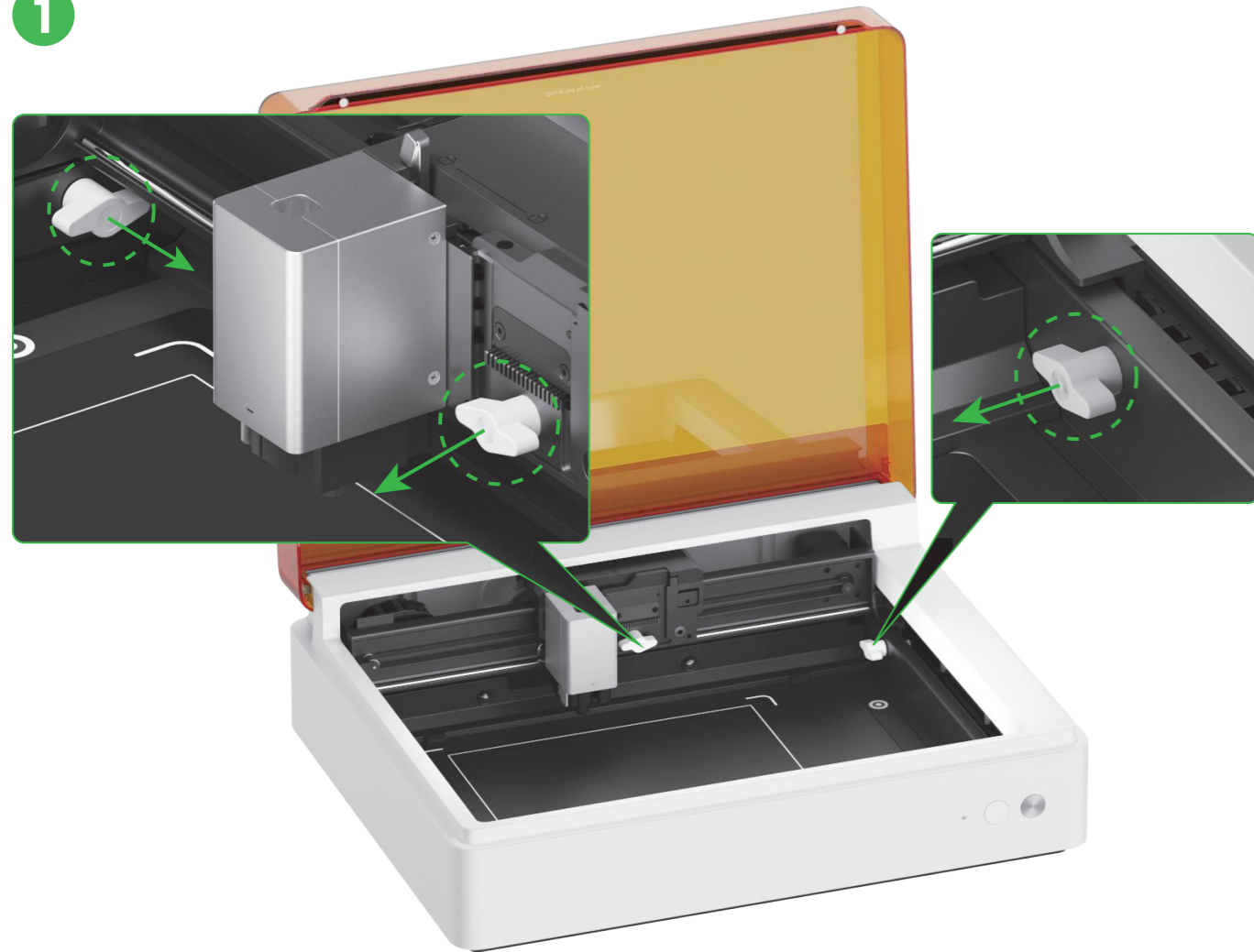

2

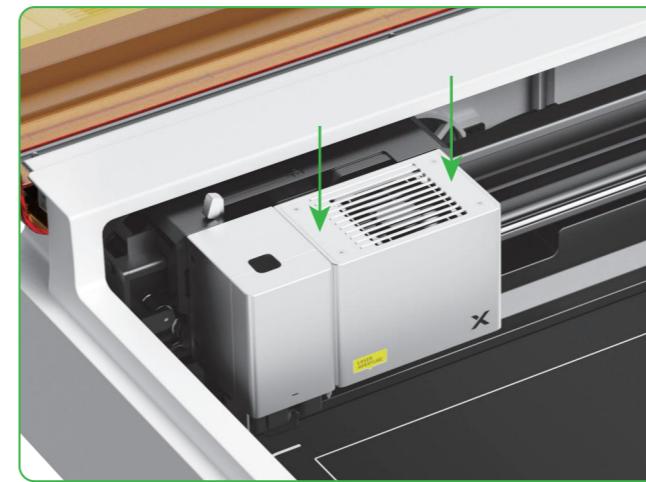
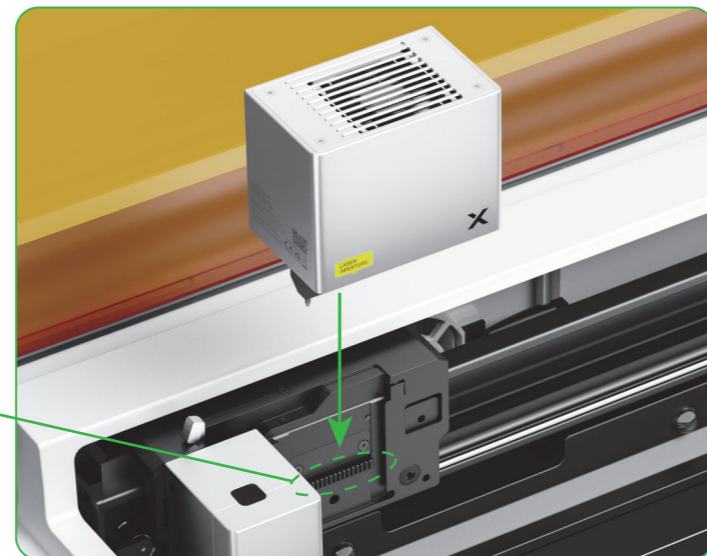

Pulse el módulo láser hacia abajo hasta que oiga un clic.



3



No utilice el módulo de salida de humos sin el filtro. O puede absorber humo y polvo y estropearse.

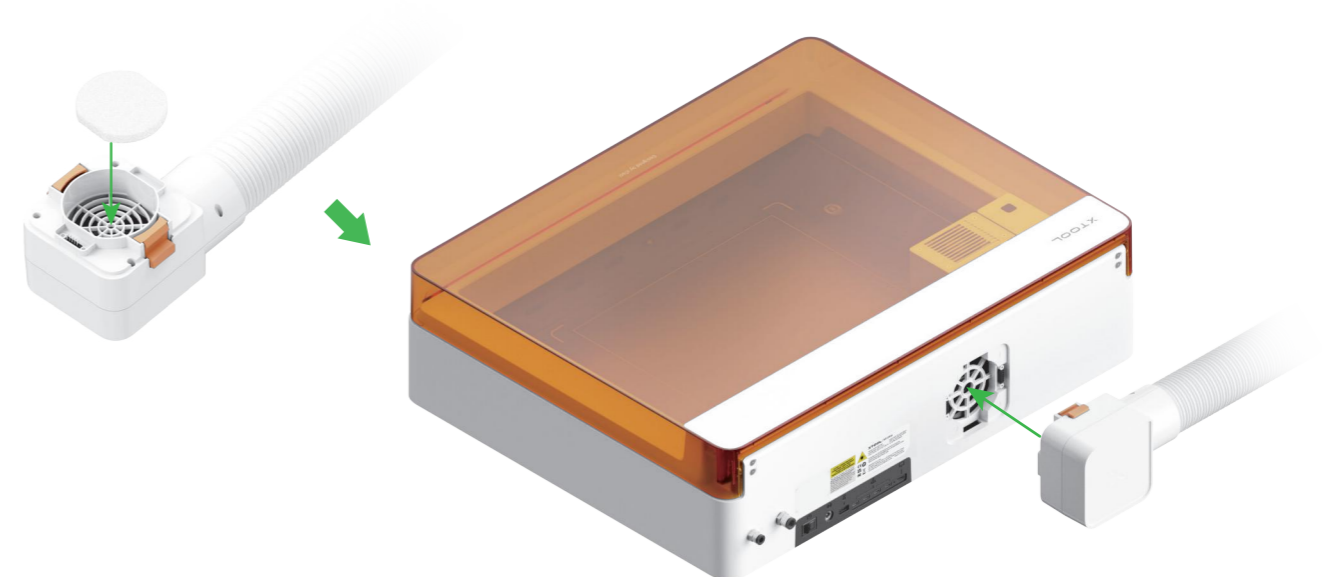

4

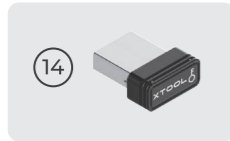

Inserte la llave para desbloquear el procesamiento y las funciones relacionadas. Puede retirar la llave para bloquear el procesamiento y las funciones relacionadas.

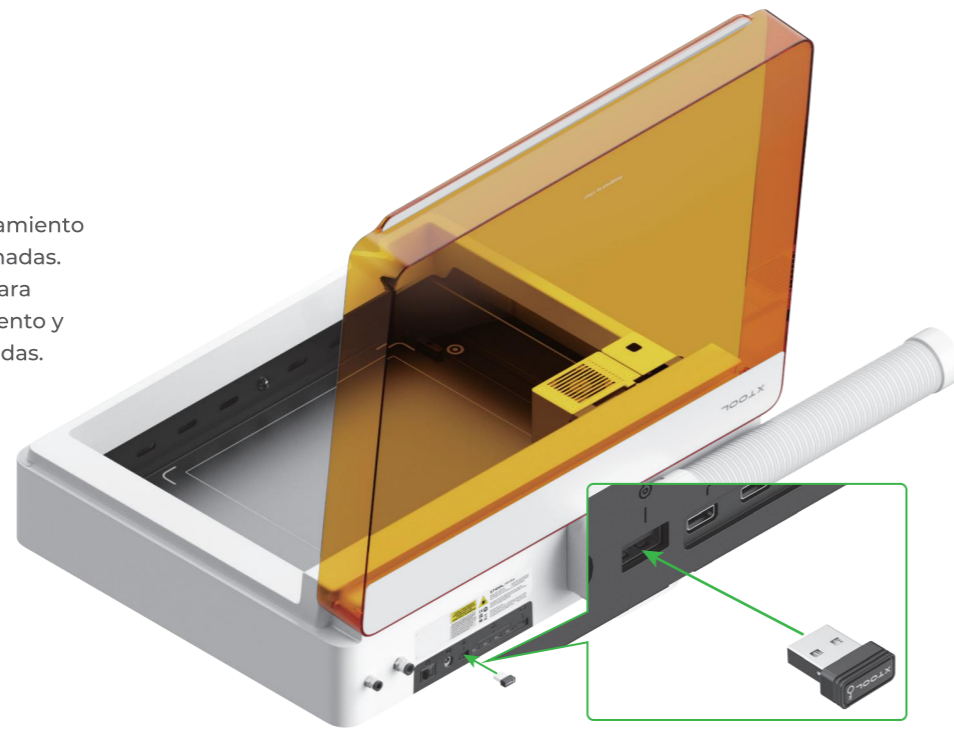

5

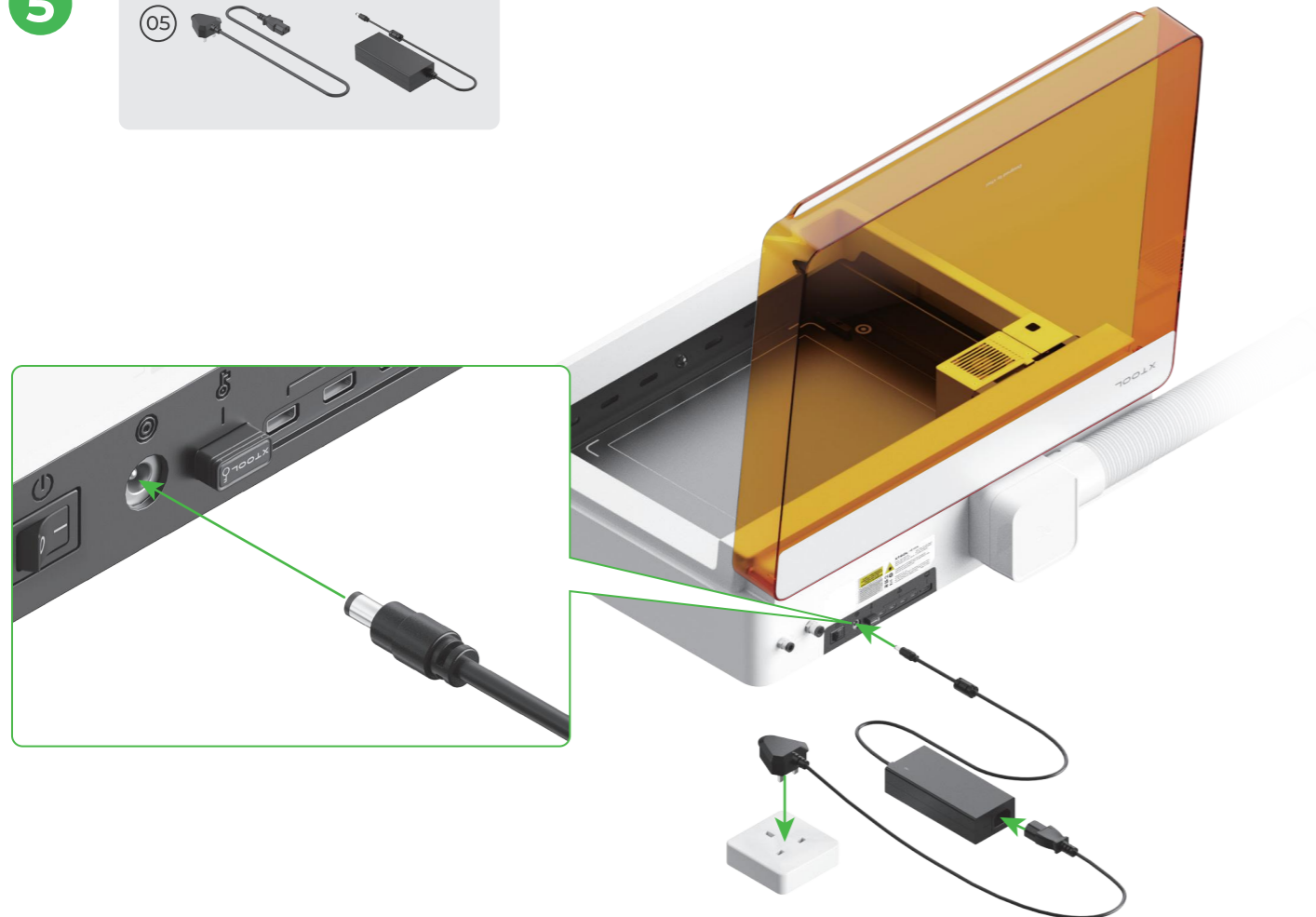
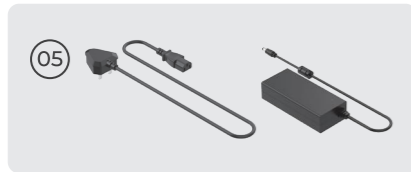

6



Visite xtool.com/software para descargar e instalar xTool Creative Space (XCS).

Busque **xTool Creative Space** en el app store o escanee el siguiente código QR para descargar la aplicación.

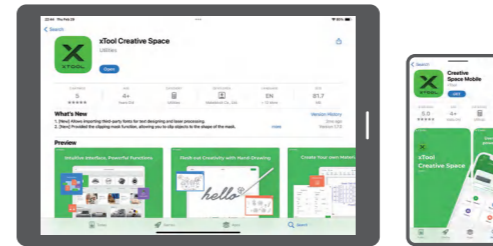

7

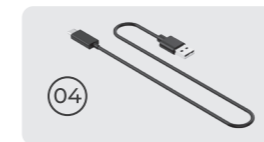

Encienda xTool M1 Ultra, conéctelo a un dispositivo, y luego conéctelo a XCS.



Para conocer más detalles, escanea el siguiente código QR.



support@xtool.com

Utilice xTool M1 Ultra

Para corte con láser

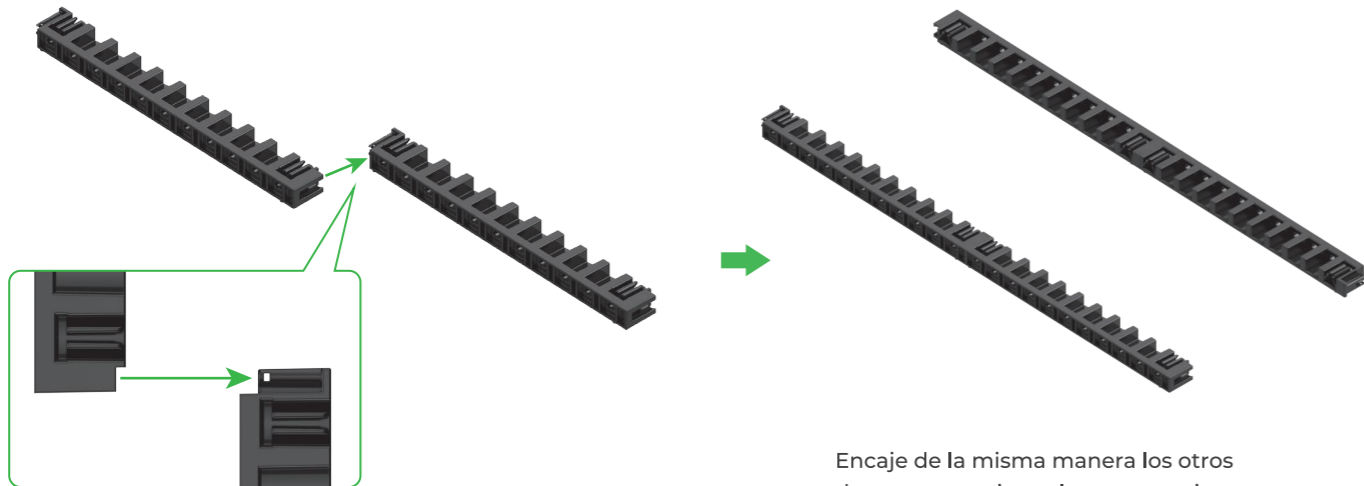
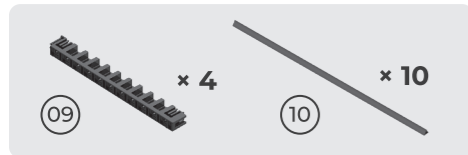

Encaje de la misma manera los otros dos soportes triangulares para prismas.

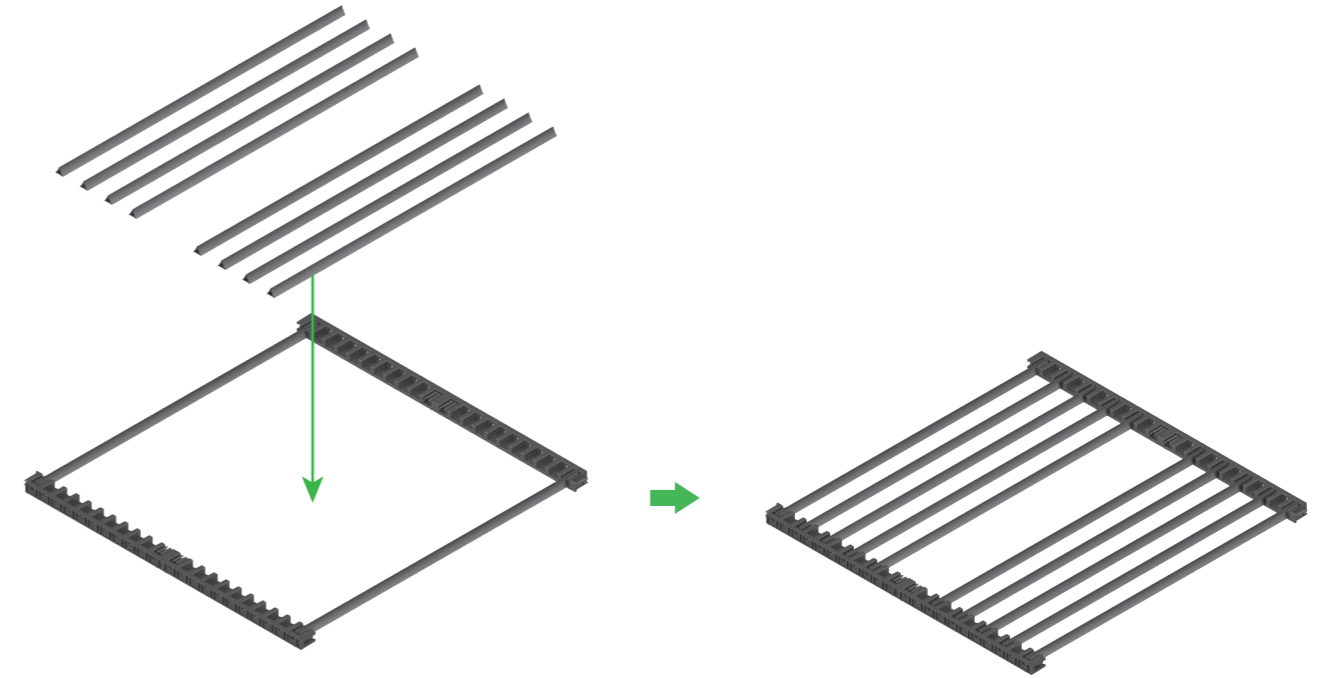
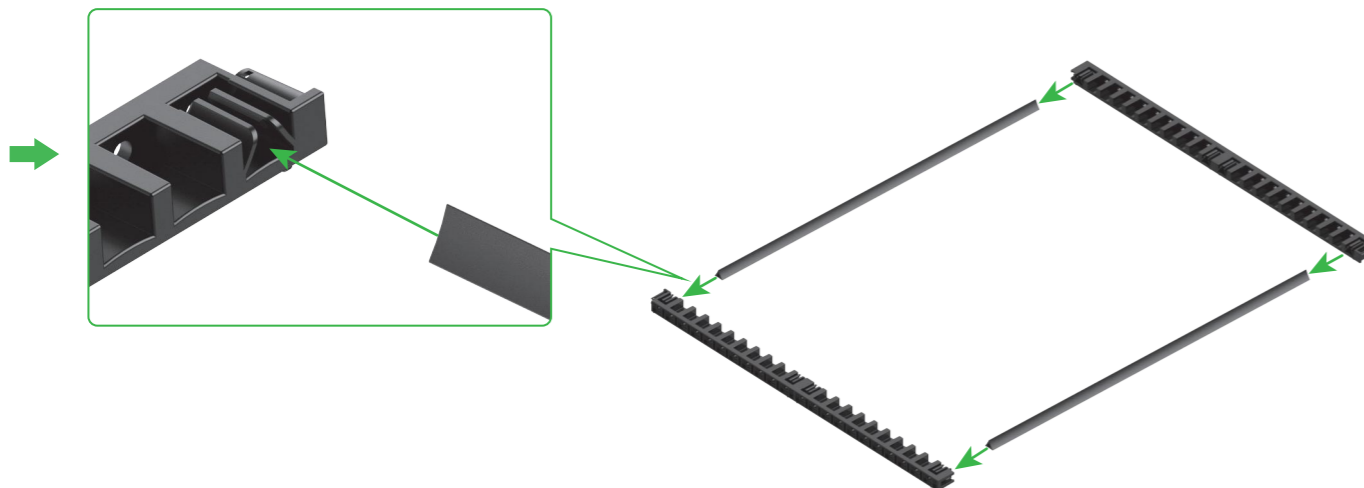

Determine el número de los prismas triangulares en función del material a procesar.

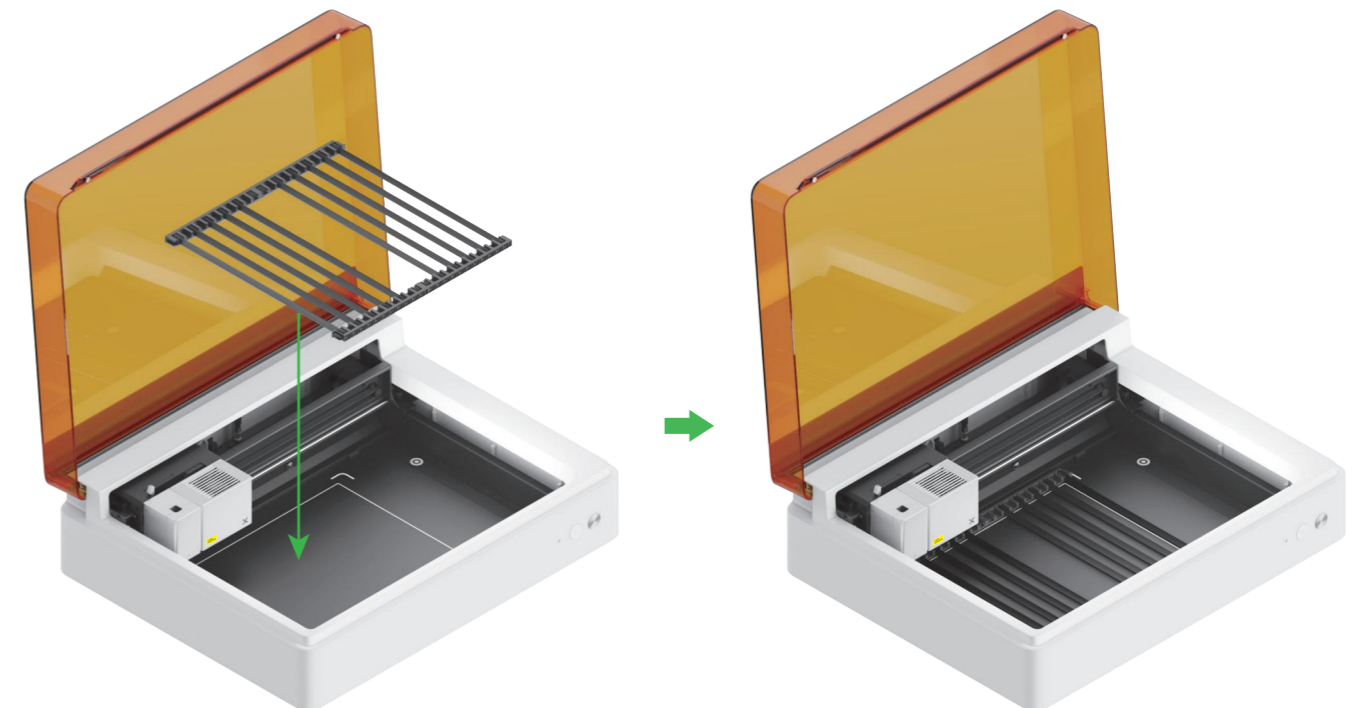

Para corte de cuchillas o combinación de procesamiento láser y corte de cuchillas

1

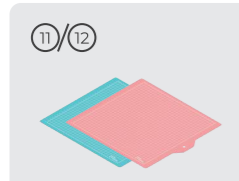

Nota: Para materiales de papel como cartón y papel kraft, utilice la alfombrilla de corte LightGrip; y para materiales de tejido como tela, utilice la alfombrilla de corte FrabicGrip. No utilice ninguna alfombrilla de corte cuando corte un material con rayos láser.

Alfombrilla de corte		
Color	Azul	Rosa
Se aplica a	Materiales ligeros	Textiles
Material	Cartón, Papel de envolver, Papel de impresión Papel Kraft, Papel perla	Textil

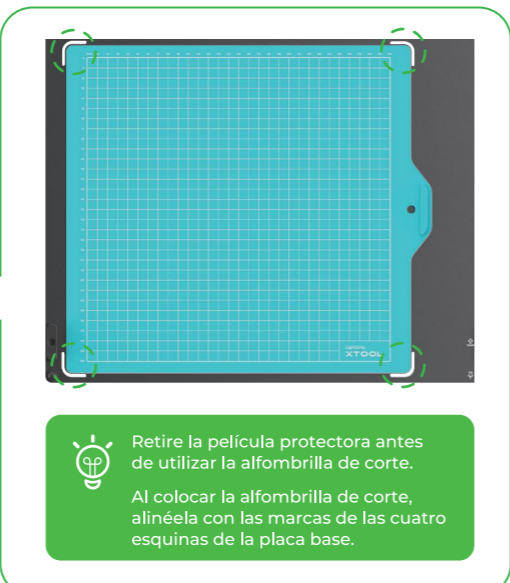
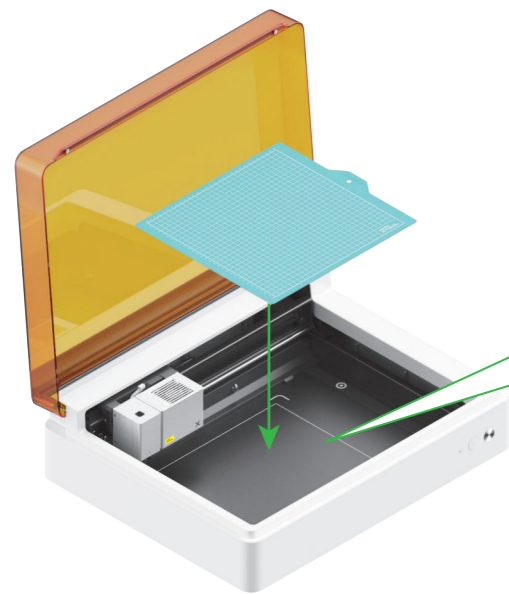

Retire la película protectora antes de utilizar la alfombrilla de corte.
Al colocar la alfombrilla de corte, alinéela con las marcas de las cuatro esquinas de la placa base.

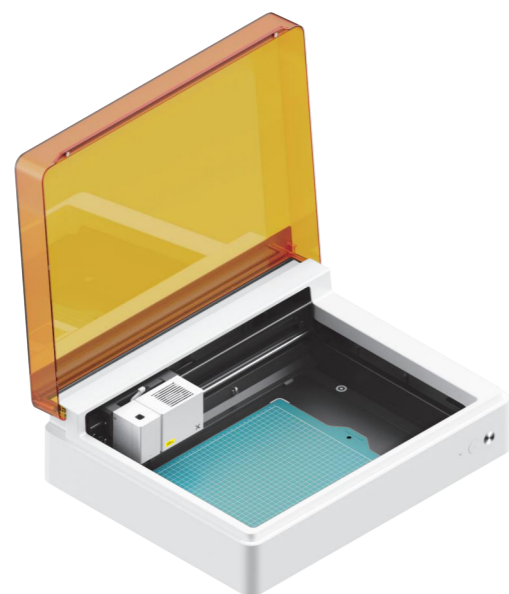

2

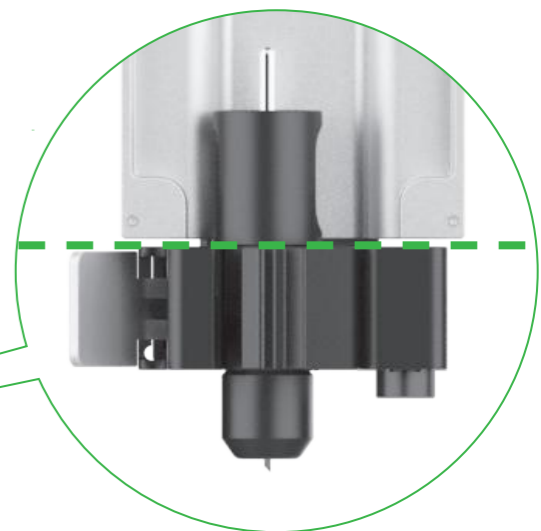
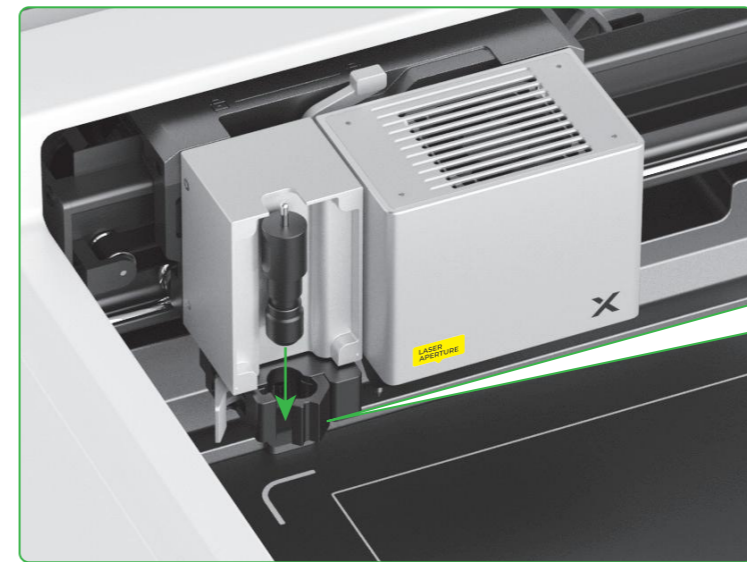
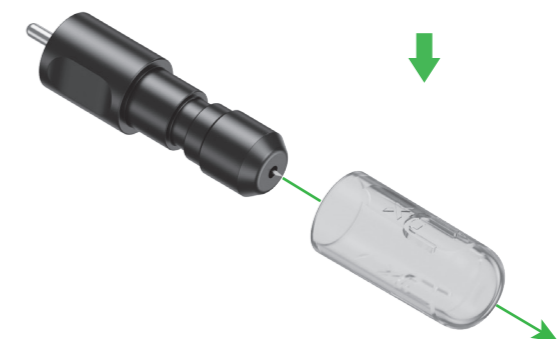
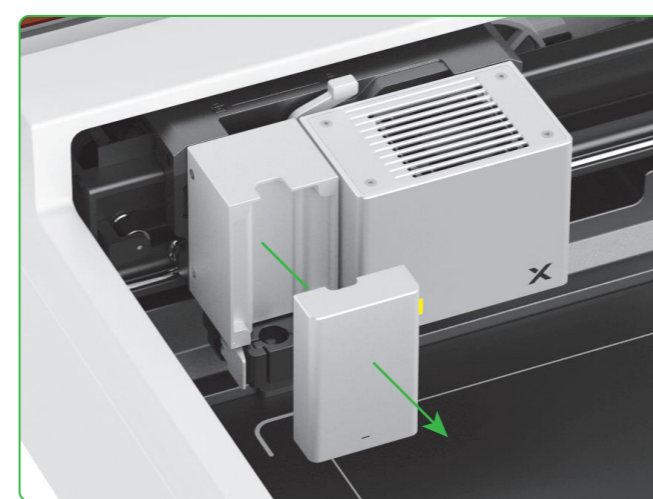

¡Cuidado!
Cuchilla afilada

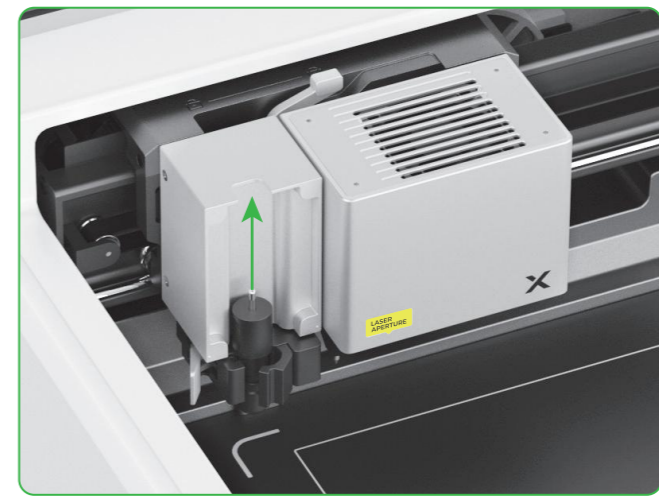
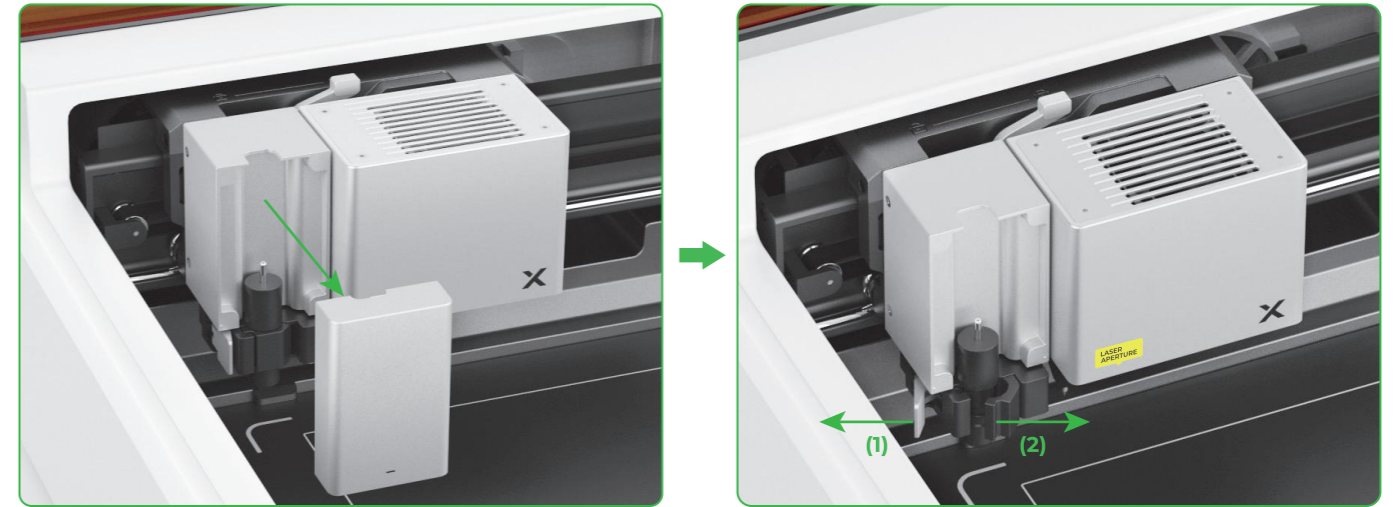
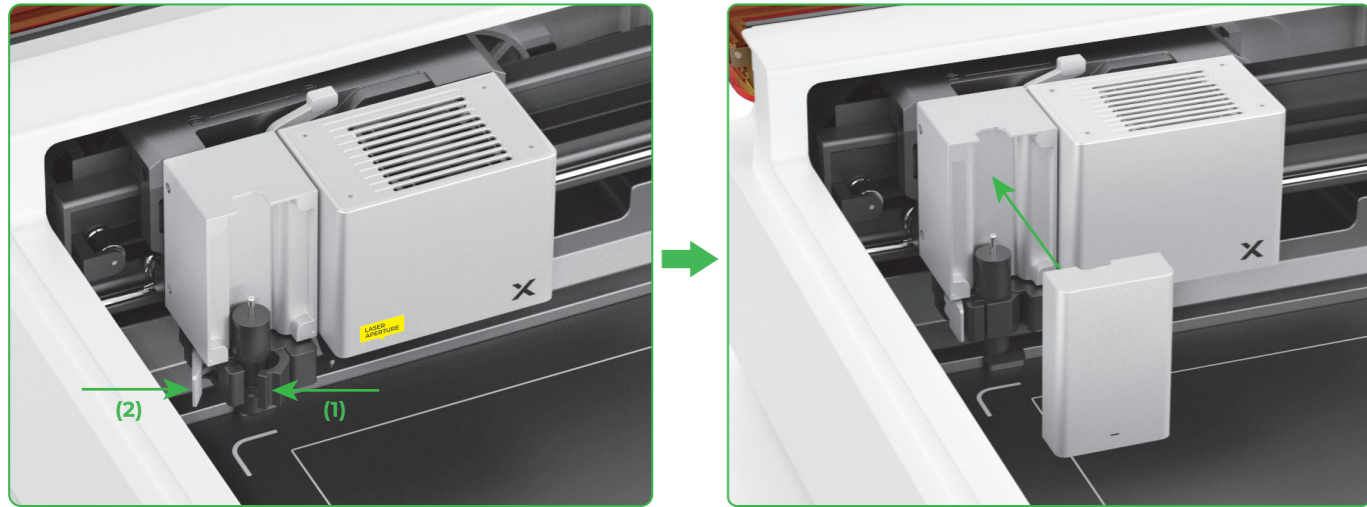



¡Cuidado!
 Cuchilla afilada

Para dibujar con bolígrafo

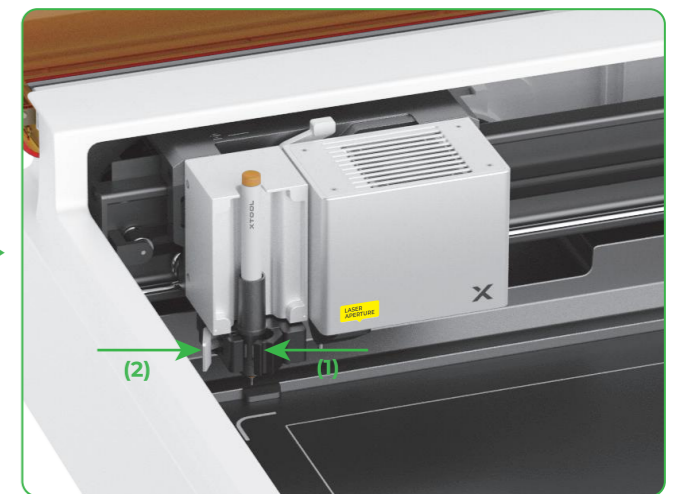
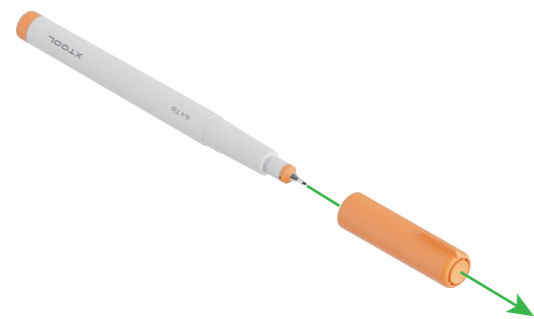

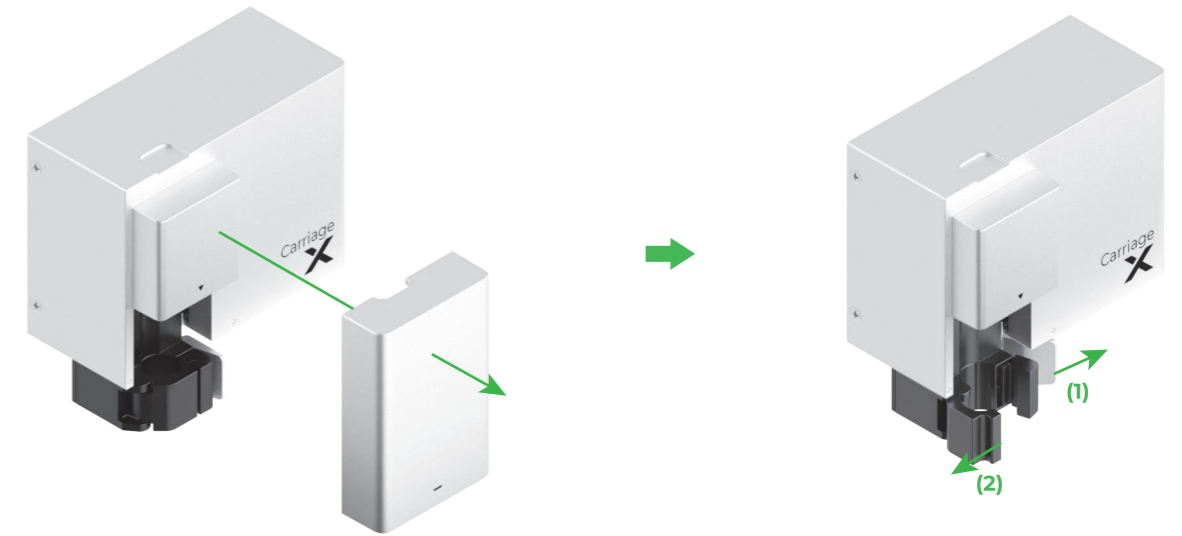
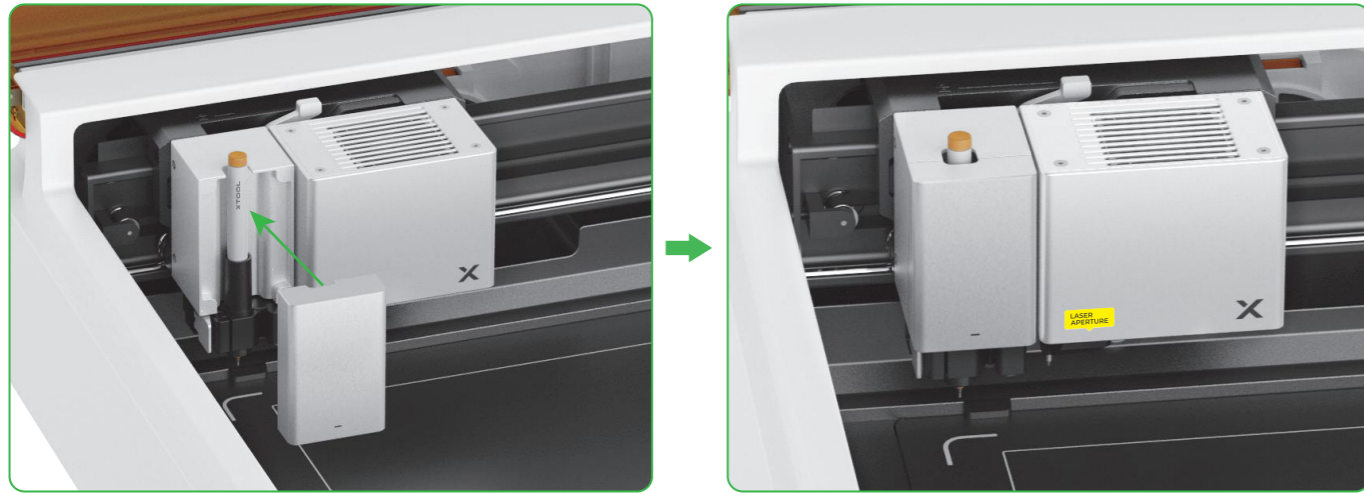

Para más funciones

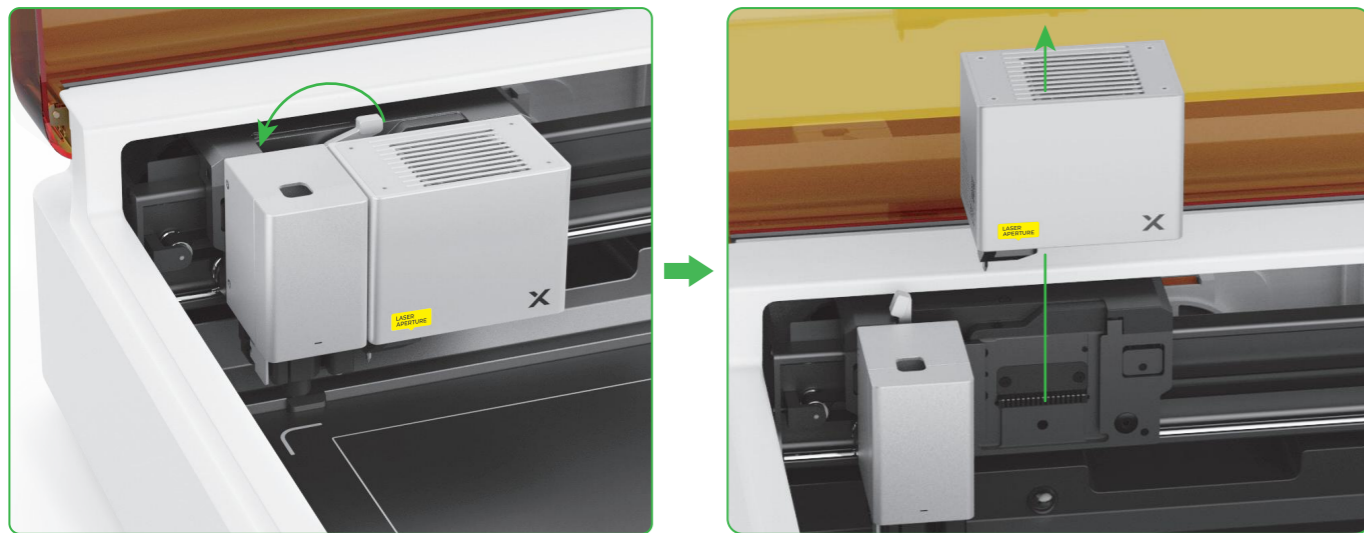
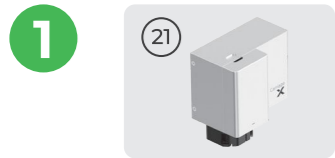

2 Seleccione los accesorios en función de las necesidades de procesamiento.

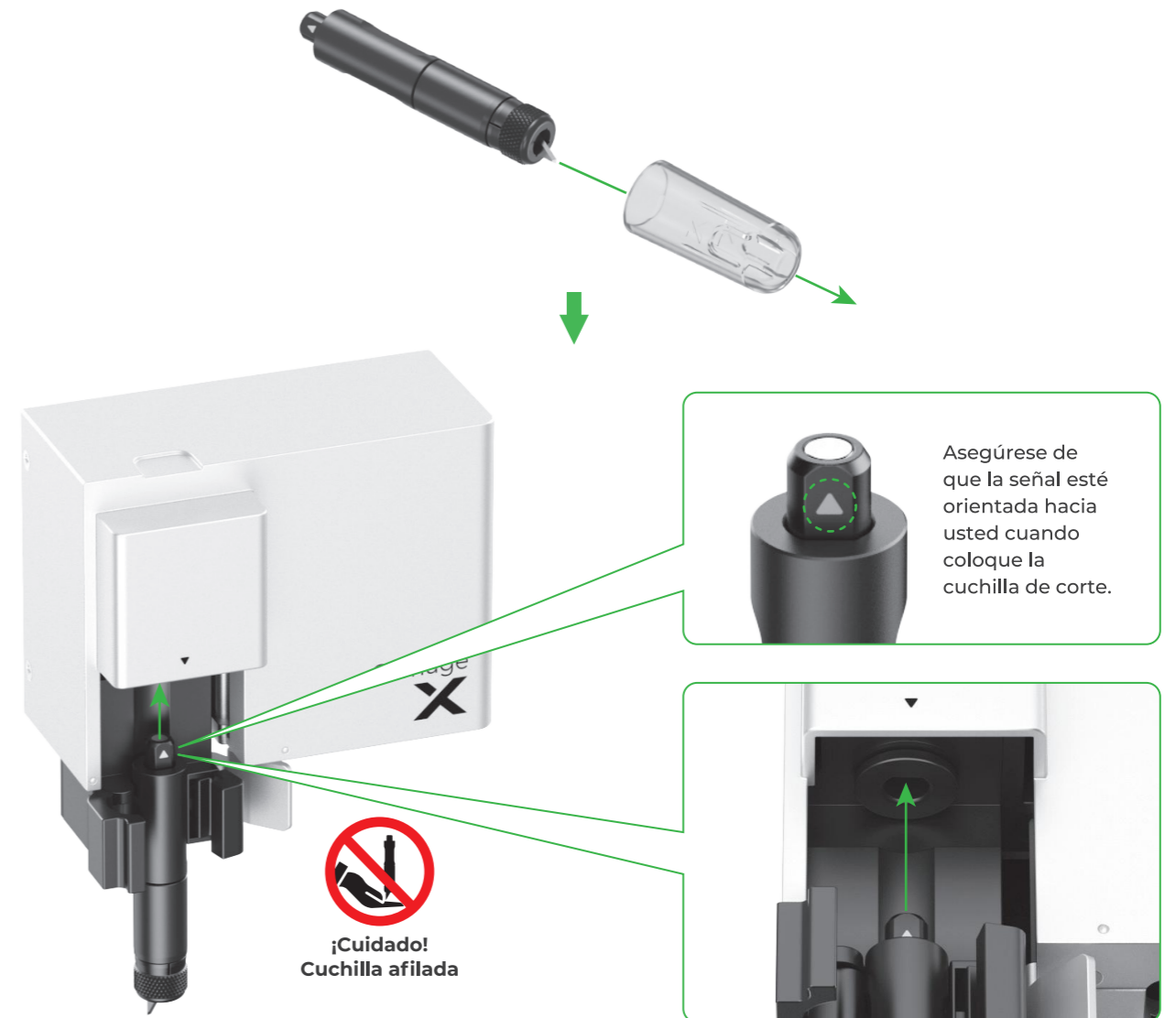

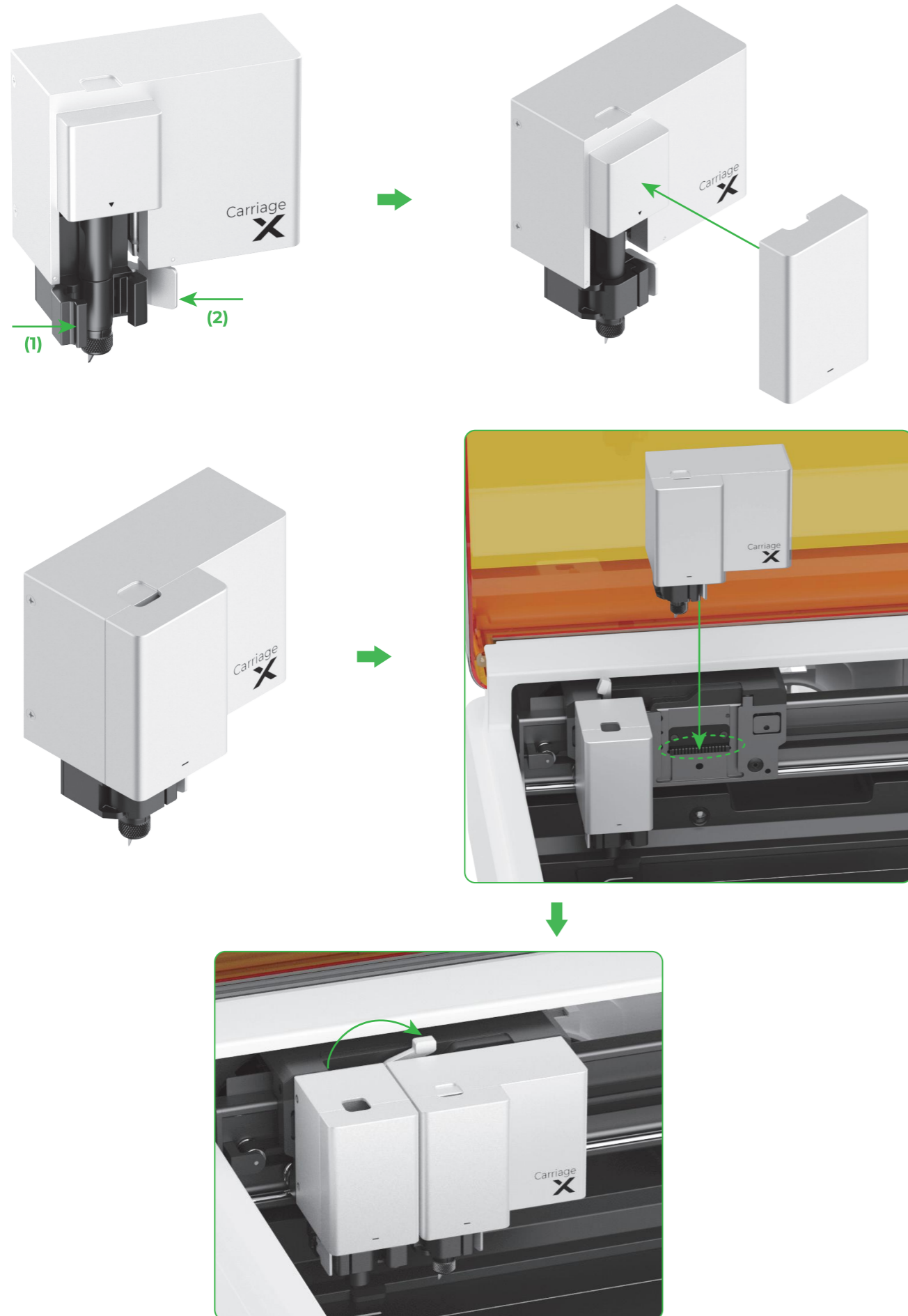

Descripción del indicador

Estado del indicador	Estado del avisador acústico	Estado de la máquina
○ Blanco fijo	/	En espera, no conectado a XCS (en modo AP)
○ Azul claro sólido	/	En espera, no conectado a XCS (en modo STA)
○ Violeta fijo	Suena una vez	En espera, conectado a XCS
○ Blanco transpirante	/	En reposo, no conectado a XCS
○ Violeta transpirante	/	En reposo, conectado a XCS
○ Violeta intermitente lento	/	Actualización del firmware
○ Verde fijo	/	Marcado del área de procesamiento en XCS / Encuadre / Procesamiento
○ Azul intermitente lento	Suena una vez	Listo para enmarcar / Listo para procesar
○ Azul fijo	/	Tarea pausada
○ Amarillo intermitente	Suena una vez	La tapa está abierta o no está completamente cerrada durante la operación.
○ Amarillo intermitente	Sigue sonando	Llama detectada (llama pequeña) / Dispositivo agitado
○ Rojo intermitente	Sigue sonando	Se detecta una llama (llama grande)
○ Amarillo intermitente	Suena tres veces	Se producen excepciones
○ Rojo intermitente	Suena tres veces	Se producen grandes excepciones

Mantenimiento

Sustituir el filtro

13



No utilice el filtro si está húmedo.

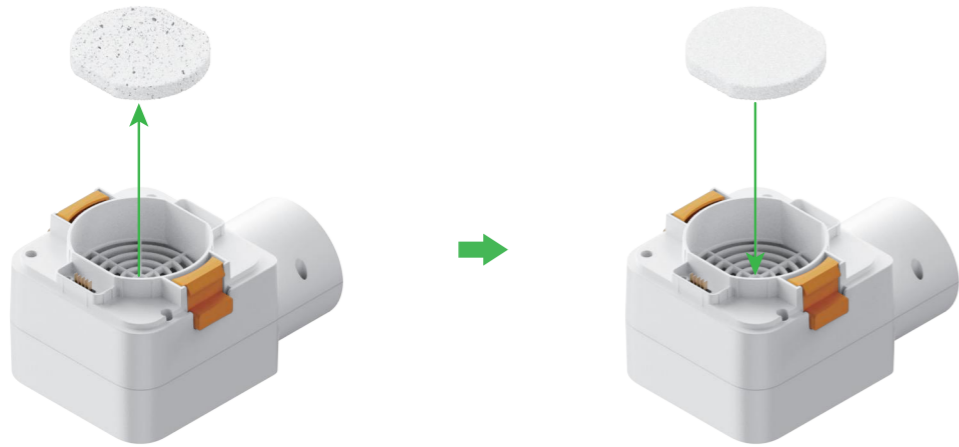

Sustituir la moldura del objetivo

18

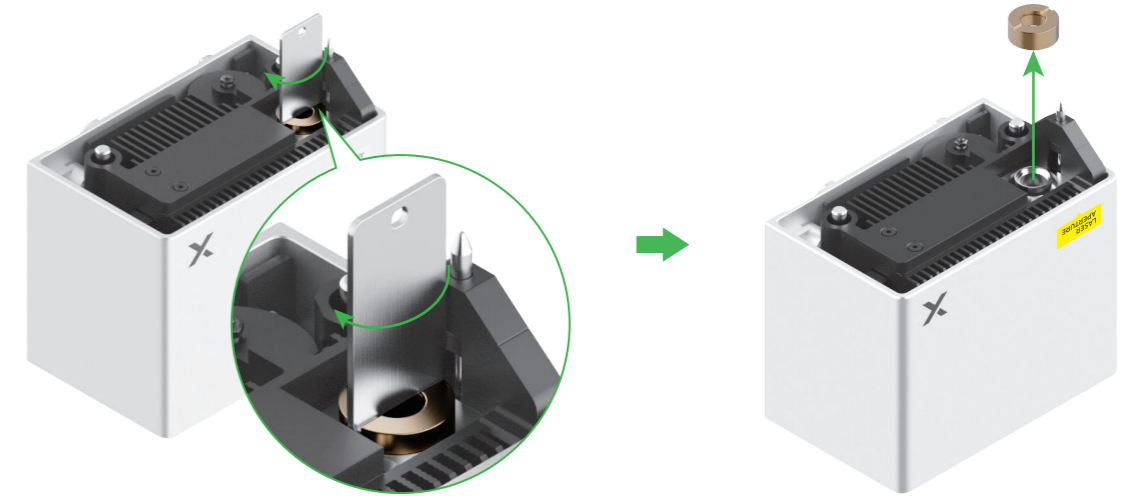
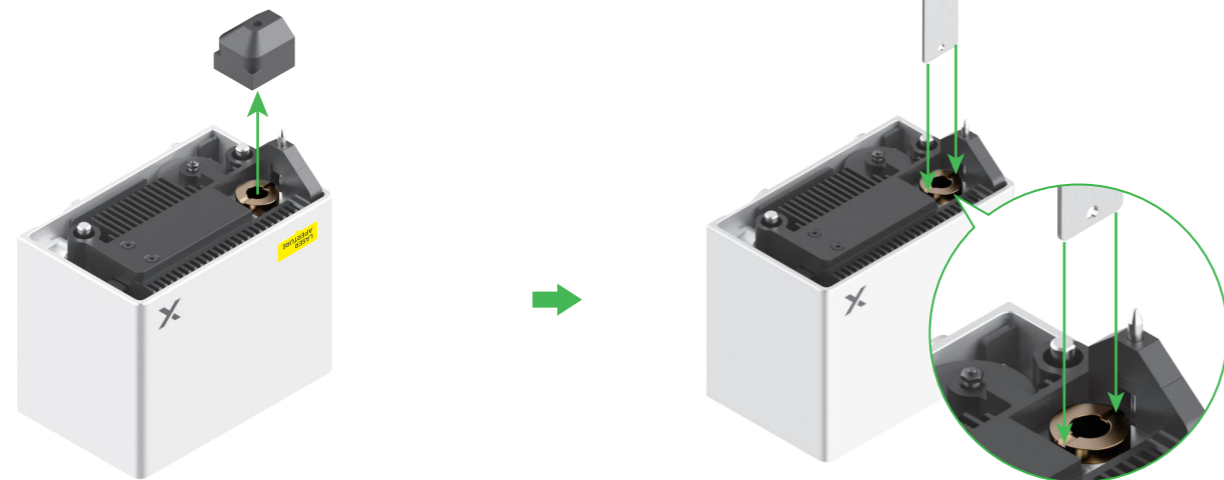
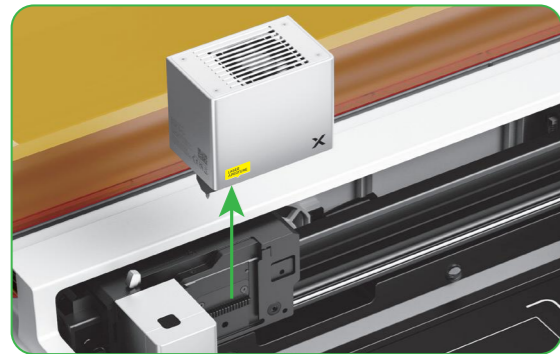

17

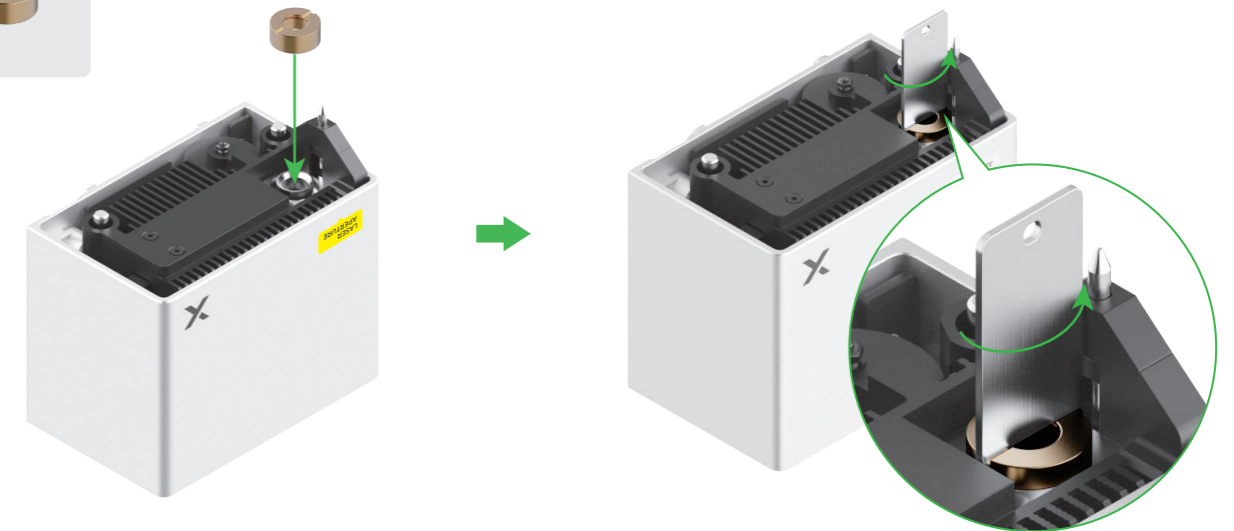
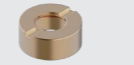

Limpie la sonda

La sonda puede ensuciarse tras un largo periodo de procesamiento láser. Límpiela a tiempo o la precisión del enfoque puede verse reducida.

Se recomienda limpiar la sonda con un paño sin pelusas humedecido con alcohol.

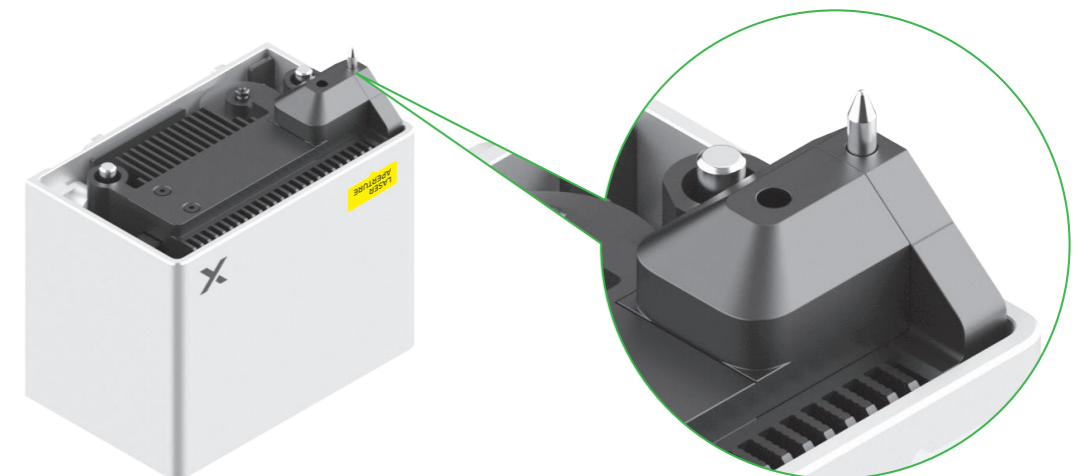

Preguntas frecuentes

1. El módulo de salida de humos no funciona durante el procesamiento del material. ¿Qué puedo hacer?

Posibles causas y soluciones:

Se acumula demasiado polvo en el extractor. / El filtro se bloquea.

Soluciones:

- (1) Apague xTool M1 Ultra y retírelo antes de sustituir el módulo de salida de humo.
- (2) Sustituir el filtro.
- (3) Vuelva a instalar el módulo de salida de humos en xTool M1 Ultra.

2. El módulo láser / carro multifunción no funciona correctamente. ¿Por qué?

Posibles causas y soluciones:

- El módulo láser/carro multifunción no está instalado correctamente.
- La barra de bloqueo situada sobre el módulo láser no está bloqueada.

Soluciones:

- Empuje el módulo láser / carro multifunción hacia abajo hasta que oiga un clic.
- Una vez colocado el módulo láser o el carro multifunción, gire la barra de bloqueo hacia la derecha para bloquearla.

3. La placa base o la alfombrilla de corte están sucias debido a un procesamiento prolongado. ¿Qué puedo hacer?

- Cada vez que finalice el procesamiento, limpie la placa base o el prisma triangular con un paño de limpieza humedecido con agua y séquelo.
- Si la placa base está muy sucia y es difícil de limpiar, límpiela con un paño de limpieza humedecido con alcohol etílico absoluto.

4. ¿Cuándo debo cambiar el filtro?

La frecuencia de cambio varía según el material. Debe reemplazar el filtro si:

- Una ventana emergente en XCS le pide que sustituya el filtro.
- El humo y los gases se acumulan mucho en el interior del aparato.

5. Cuando utilizo un rotulador naranja para procesar, no puedo ver las líneas trazadas por el rotulador. ¿Por qué?

Porque la tapa es naranja.

Declaración de conformidad

Makeblock Co. Ltd. declara por la presente que este producto cumple los requisitos esenciales y otras disposiciones pertinentes de la directiva RED 2014/53/UE y la directiva RoHS 2011/65/UE.

Servicio de posventa

Para soporte técnico, contáctese con nosotros a través de support@xtool.com.

Para más información acerca de los servicios posventa, visite support.xtool.com.



Déclaration	74
La sécurité d'abord (Important)	74
Liste des éléments	76
Découvrez votre xTool M1 Ultra	78
Préparations	80
Utiliser xTool M1 Ultra	84
Description de l'indicateur	93
Entretien	94
FAQs	96
Déclaration de conformité	96
Services après-vente	96

Déclaration

Bienvenue sur les produits xTool !

En cas de première utilisation du produit, lisez attentivement tous les documents d'accompagnement du produit afin d'améliorer votre expérience avec celui-ci. La société ne sera pas responsable des pertes qui résulteront d'une utilisation incorrecte du produit selon les instructions et les exigences du manuel, ou d'une mauvaise utilisation du produit en raison d'un malentendu de votre part.

La société a rassemblé le contenu du manuel avec rigueur et attention, mais il est possible qu'il subsiste des erreurs ou des omissions.

La société s'engage à améliorer continuellement les fonctions des produits et la qualité du service, et se réserve donc le droit de modification de tout produit ou logiciel décrit dans le manuel et le contenu du manuel à tout moment.

Le manuel est destiné à vous aider à utiliser le produit correctement et ne comprend aucune description de la configuration matérielle et logicielle. Reportez-vous au contrat correspondant (le cas échéant) et à la liste de colisage pour la configuration du produit, ou consultez votre distributeur. Les images du manuel sont fournies à titre de référence uniquement et le produit réel peut varier.

Protégé par les lois et réglementations sur le droit d'auteur, le manuel ne doit pas être reproduit ou transcrit de quelque manière que ce soit, ni transmis sur un réseau avec ou sans fil de quelque manière que ce soit, ni traduit dans quelque langue que ce soit, ni modifié de quelque manière que ce soit, notamment en ce qui concerne le contenu, les images ou la mise en page, sans l'autorisation écrite préalable de la société.

La Société s'engage à améliorer en permanence le produit et les matériaux associés. Le produit et le Manuel sont soumis à modification, et les mises à jour sont disponibles à l'adresse xtool.com.

La sécurité d'abord (Important)

1. Sécurité générale

Avant d'utiliser la machine, lisez et familiarisez-vous avec toutes les précautions et procédures de sécurité. Les utilisateurs doivent suivre strictement toutes les précautions de sécurité et s'assurer que le xTool M1 Ultra est correctement assemblé.



Veillez observer les principes de fonctionnement suivants :

- Assurez-vous de vérifier que la xTool M1 Ultra n'est pas endommagée à chaque fois avant de l'utiliser. Ne faites pas fonctionner un xTool M1 Ultra endommagé ou défectueux de quelque manière que ce soit.
- Veillez à ce que l'espace de travail soit propre et plat.
- Sans autorisation, veuillez ne pas démonter ou modifier la

structure de la xTool M1 Ultra de quelque manière que ce soit ; et veuillez ne pas modifier ou décompiler le système d'exploitation de la xTool M1 Ultra.

- Ne pas laisser la machine sans surveillance lorsqu'elle fonctionne. Faites attention à ce qu'elle fonctionne correctement.
- Veuillez garder l'intérieur de la xTool M1 Ultra propre. Les résidus et les copeaux accumulés pendant la découpe et la gravure sont dangereux et peuvent provoquer un incendie. Nettoyez régulièrement les copeaux et les résidus dans la zone de travail.
- La température de fonctionnement du laser est comprise entre 0°C et 35°C, la température de stockage est de -10°C et 40°C Il est strictement interdit de travailler à une température inférieure à 0°C.
- Ce produit n'est pas réparable par l'utilisateur. Il doit être renvoyé à l'usine ou réparé par des professionnels agréés.

2. Sécurité du laser

De manière générale, le module laser est entièrement intégré dans le boîtier et la protection de la lumière pendant le fonctionnement. Le xTool M1 Ultra est équipé d'un interrupteur de sécurité. Si pendant le fonctionnement, le couvercle est soulevé, la xTool M1 Ultra cessera de fonctionner.



Veillez respecter les consignes de sécurité suivantes:

- Équipement destiné à être utilisé dans des lieux où les enfants ne sont pas susceptibles d'être présents.
- Assurez-vous que l'espace de travail est bien aéré, afin que la fumée générée puisse être évacuée en temps voulu.
- Veuillez noter que les matériaux empilés (en particulier les matériaux organiques tels que le papier) peuvent provoquer la propagation de la flamme ou augmenter le risque d'inflammation du matériau. (en particulier l'extrémité du tuyau d'échappement de la fumée)
- Ne laissez jamais le xTool M1 Ultra sans surveillance pendant son fonctionnement. Si le xTool M1 Ultra est démarré en raison de réglages incorrects et laissé sans surveillance pendant de longues périodes, ou si le xTool M1 Ultra présente un dysfonctionnement mécanique ou électrique pendant son fonctionnement, il y a un risque d'incendie.
- Nettoyez régulièrement la xTool M1 Ultra. Le risque d'incendie serait accru par une accumulation excessive de résidus et d'écaillures provenant de la découpe et de la gravure. La zone de travail interne doit être régulièrement nettoyée afin d'assurer l'absence de résidus ou de copeaux dans l'appareil.
- Maintenez la zone autour du xTool M1 Ultra propre et exempte de matériaux inflammables encombrants, d'explosifs ou de solvants volatils tels que l'acétone, l'alcool ou l'essence.
- Conservez un extincteur et procédez régulièrement à son entretien et à son inspection.
- Si un incendie se déclenche au cours du traitement, veillez à assurer votre sécurité. Si l'incendie est réduit, vous pouvez attendre qu'il s'éteigne ; s'il est de grande envergure, maintenez une distance de sécurité et éteignez-le grâce à un extincteur.
- Il est recommandé d'utiliser le kit de sécurité incendie xTool pour graver ou découper des matériaux inflammables à l'aide du faisceau laser afin d'éviter tout risque d'incendie.

3. Sécurité incendie



Un faisceau laser à haute densité est utilisé par la xTool M1 Ultra pour irradier le matériau à découper ou à graver, de manière à chauffer la surface du matériau et à vaporiser le matériau sans le brûler. Mais la plupart des matériaux sont intrinsèquement inflammables et peuvent s'enflammer pour former une flamme ouverte qui peut brûler le xTool M1 Ultra (même s'il est fait de matériaux ignifuges) et ses environs. L'expérience montre que la découpe vectorielle au laser est la plus susceptible de produire une flamme ouverte.



Veillez lire attentivement les avertissements et suggestions suivants:

- Assurez-vous que l'espace de travail est bien aéré, afin que la fumée générée puisse être évacuée en temps voulu.
- Veuillez noter que les matériaux empilés (en particulier les matériaux organiques tels que le papier) peuvent provoquer la propagation de la flamme ou augmenter le risque d'inflammation du matériau. (en particulier l'extrémité du tuyau d'échappement de la fumée)
- Ne laissez jamais le xTool M1 Ultra sans surveillance pendant son fonctionnement. Si le xTool M1 Ultra est démarré en raison de réglages incorrects et laissé sans surveillance pendant de longues périodes, ou si le xTool M1 Ultra présente un dysfonctionnement mécanique ou électrique pendant son fonctionnement, il y a un risque d'incendie.
- Nettoyez régulièrement la xTool M1 Ultra. Le risque d'incendie serait accru par une accumulation excessive de résidus et d'écaillures provenant de la découpe et de la gravure. La zone de travail interne doit être régulièrement nettoyée afin d'assurer l'absence de résidus ou de copeaux dans l'appareil.
- Maintenez la zone autour du xTool M1 Ultra propre et exempte de matériaux inflammables encombrants, d'explosifs ou de solvants volatils tels que l'acétone, l'alcool ou l'essence.
- Conservez un extincteur et procédez régulièrement à son entretien et à son inspection.
- Si un incendie se déclenche au cours du traitement, veillez à assurer votre sécurité. Si l'incendie est réduit, vous pouvez attendre qu'il s'éteigne ; s'il est de grande envergure, maintenez une distance de sécurité et éteignez-le grâce à un extincteur.
- Il est recommandé d'utiliser le kit de sécurité incendie xTool pour graver ou découper des matériaux inflammables à l'aide du faisceau laser afin d'éviter tout risque d'incendie.

4. Sécurité des équipements électriques



Veillez lire attentivement et respecter strictement les avertissements et suggestions suivantes:

- Lorsque la xTool M1 Ultra est connectée à l'alimentation électrique, n'ouvrez aucun panneau d'accès sur la xTool M1 Ultra afin d'éviter tout dommage dû à un contact accidentel avec l'alimentation électrique.

- Lorsque la xTool M1 Ultra est connectée à l'alimentation électrique, évitez de toucher la zone électronique avec vos mains ou d'autres outils.

5. Entretien



Attention - L'utilisation de commandes ou de réglages ou l'exécution de procédures autres que celles spécifiées dans le présent document peut entraîner une exposition dangereuse aux rayonnements.

Lisez attentivement les avertissements et suggestions suivants :

- Coupez l'alimentation électrique avant de procéder à l'entretien de l'appareil.
- Évitez tout contact entre la lame et vos doigts lors du retrait du module laser ou de la lame, sous peine de vous blesser.
- Les lames sont très acérées. Faites attention à ne pas vous blesser les mains lors de l'installation ou du remplacement des lames.
- Placez les lames usagées dans un contenant permettant d'éviter toute blessure avec des outils acérés, comme une boîte métallique. Scellez le contenant et jetez-le.

6. Les avertissements et les instructions

Tous les panneaux d'avertissement et d'information fixés à votre xTool M1 Ultra sont situés dans des endroits qui peuvent être une source de danger avant et/ou pendant le fonctionnement. Les panneaux d'avertissement et d'information endommagés ou perdus doivent être remplacés immédiatement. Les panneaux d'avertissement et d'information manquants peuvent être reproduits en utilisant les modèles de la page suivante.

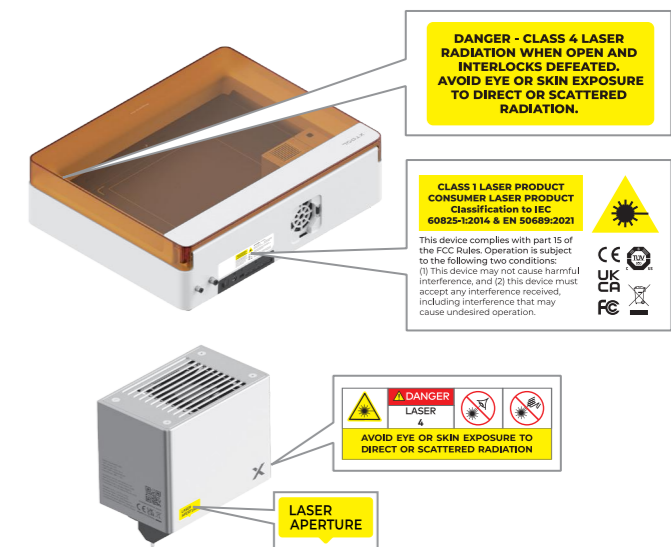

Puissance d'émission RF maximale : Wi-Fi 2.4G (2412-2472 MHz) < 20 dBm

Spécifications du laser

	Longueur d'onde	Divergence du faisceau	Puissance de sortie maximale
Laser de travail	455±5nm	1.5mrad (IEC 60825-1 Default (simplified) evaluation C6=1)	20 W
Laser indicateur	650±5nm	/	0.39 mW

Liste des éléments

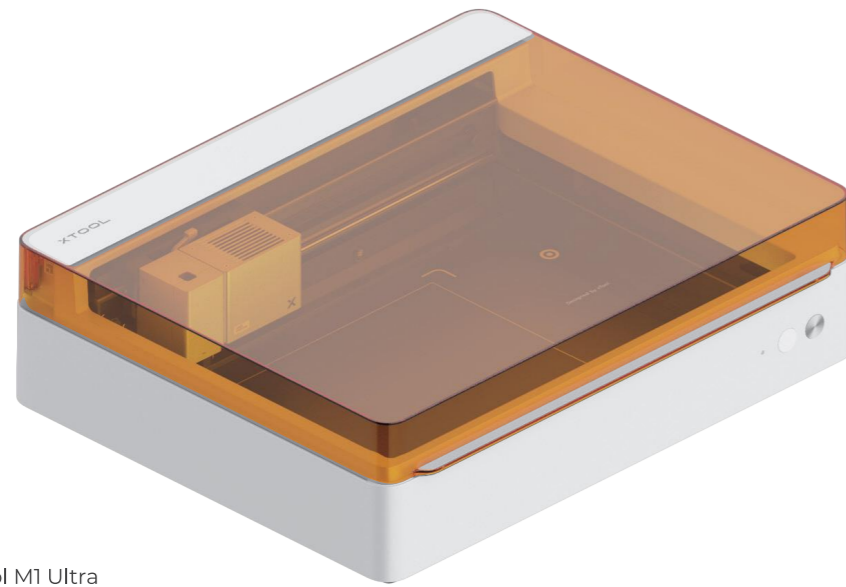

01 xTool M1 Ultra



02 Module laser

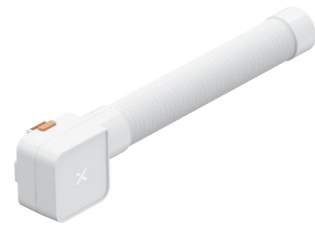

03 Module d'évacuation de fumée



04 Câble USB

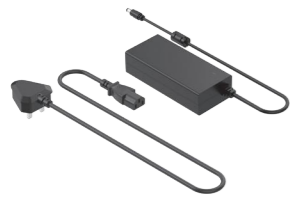

05 Adaptateur et câble d'alimentation



06 Lame à pointe fine



07 Stylo à pointe fine



08 Support pour stylo

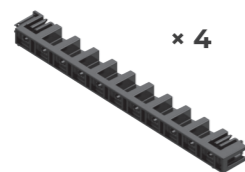

09 Support pour prisme triangulaire

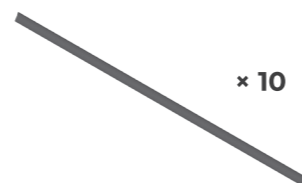

10 Prisme triangulaire

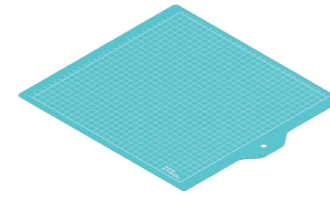

11 Tapis de coupe (LightGrip)

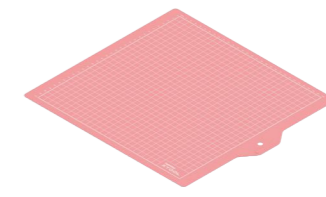

12 Tapis de coupe (FabricGrip)



13 Filtre



14 Clé



15 Graisse



16 Pack de matériaux

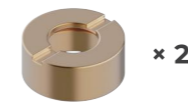

17 Support du verre (pièce de rechange)



18 Pièce rotative du support du verre



19 Tournevis



20 Manuel d'utilisation



21 Chariot multifonction



22 Lame de coupe

Découvrez votre xTool M1 Ultra

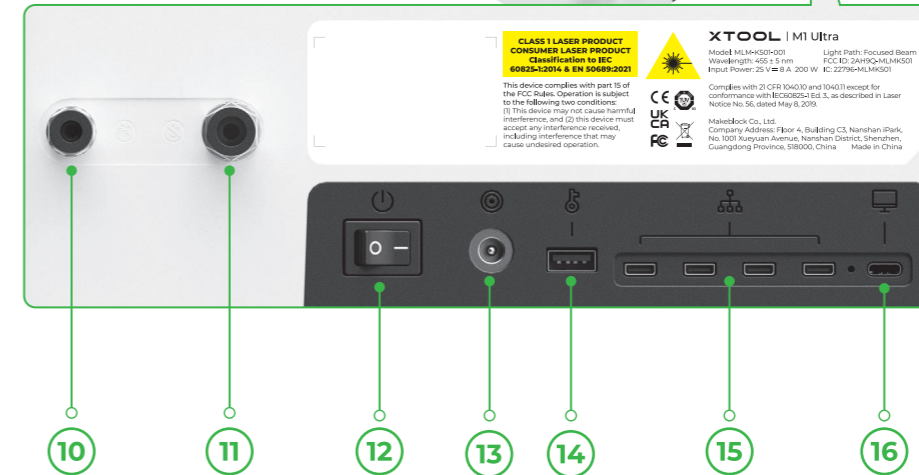
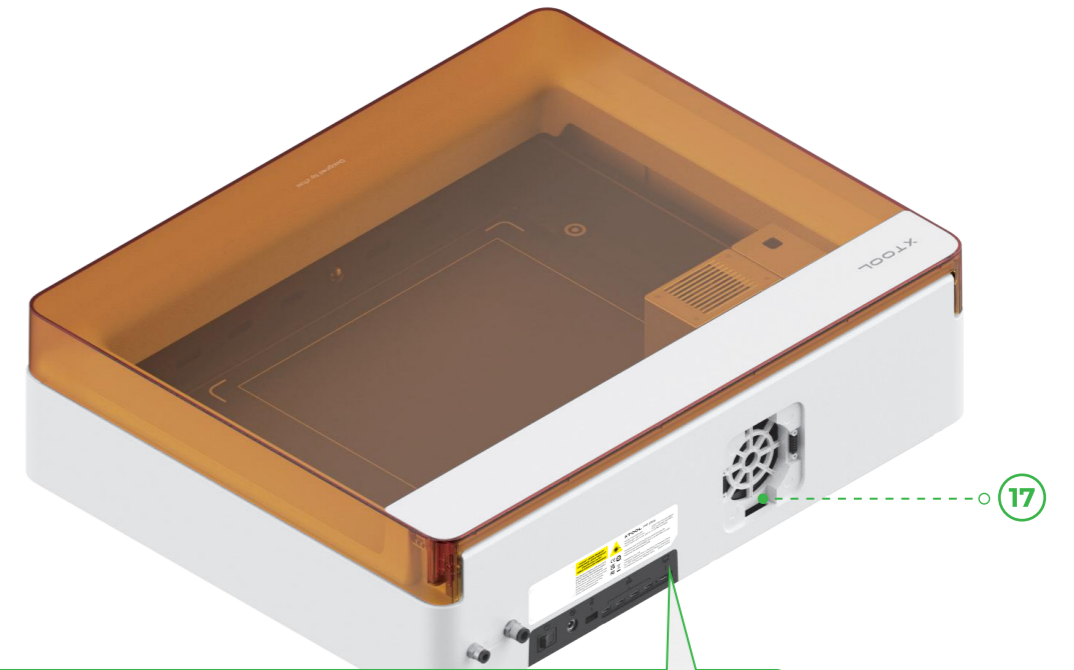
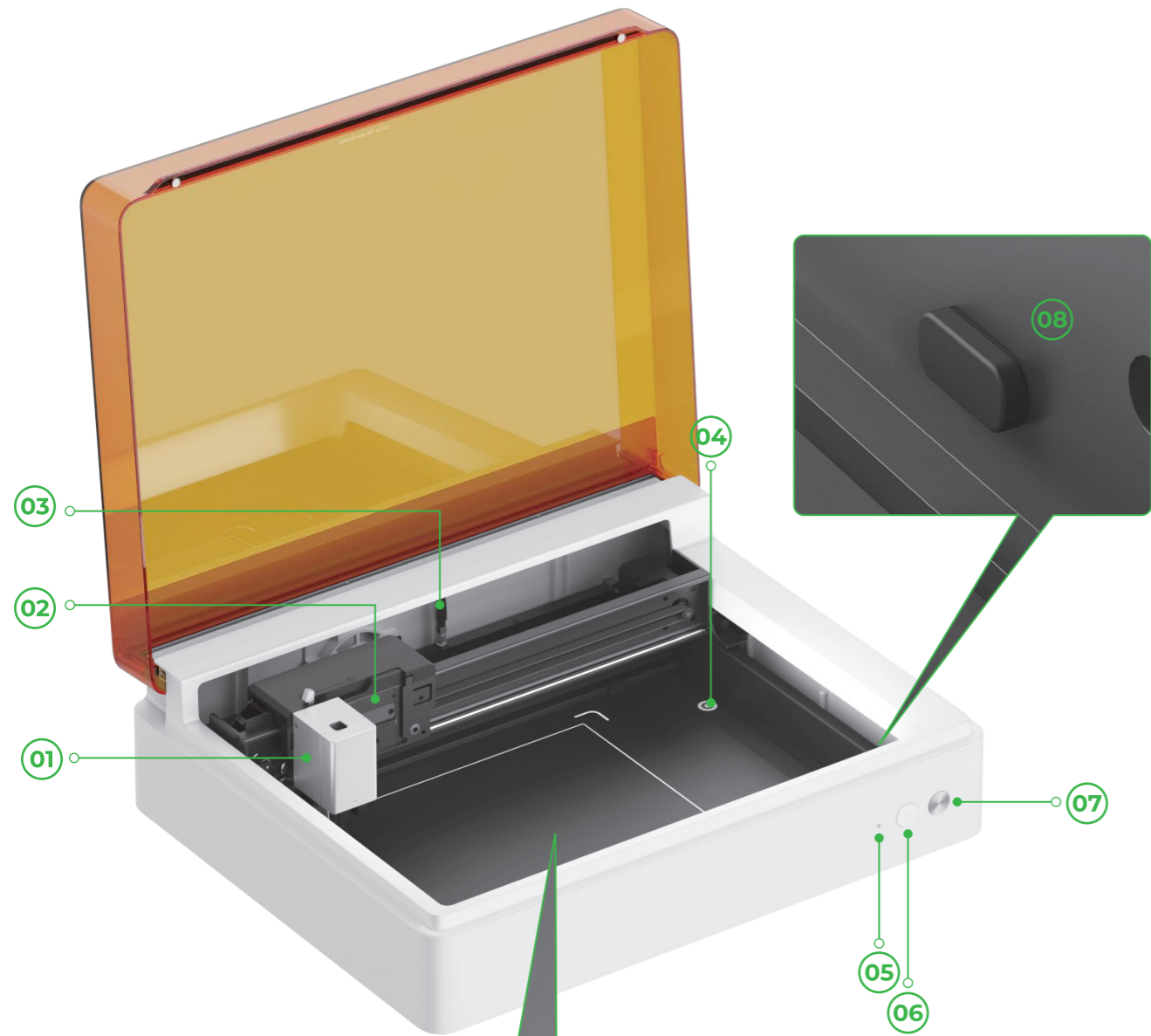

- | | | | | | |
|----|------------------------------|----|---|----|----------------------|
| 01 | Chariot basique | 07 | Bouton Démarrer/Arrêter | 13 | Port d'alimentation |
| 02 | Support multifonctions | 08 | Port de la fixation rotative | 14 | Port pour la clé |
| 03 | Antenne Wi-Fi | 09 | Vis à serrage à main pour l'embase | 15 | Port d'extension × 4 |
| 04 | Point du viseur de la caméra | 10 | Raccord de tuyaux pour l'ensemble d'assistance d'air | 16 | Port USB |
| 05 | Indicateur | 11 | Raccord de tuyaux pour le dispositif de sécurité incendie | 17 | Sortie de fumée |
| 06 | Bouton de repère du point | 12 | Interrupteur d'alimentation | | |

Préparations

1

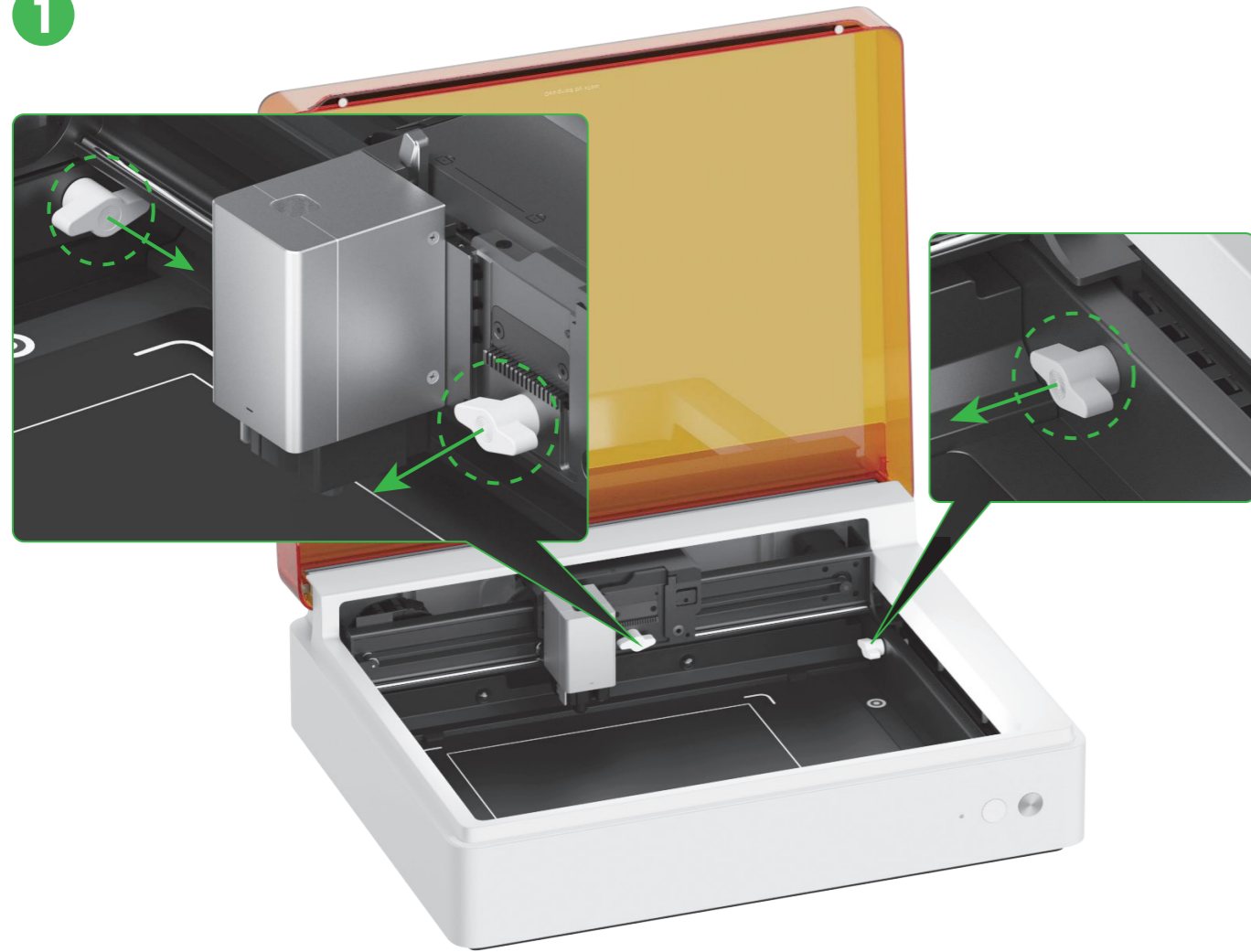

2

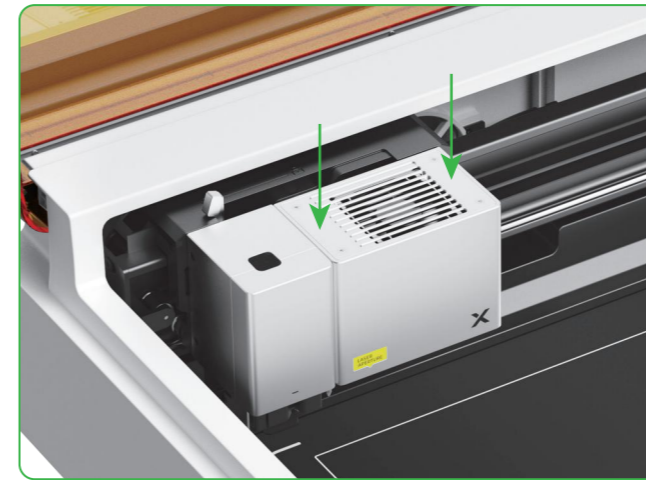
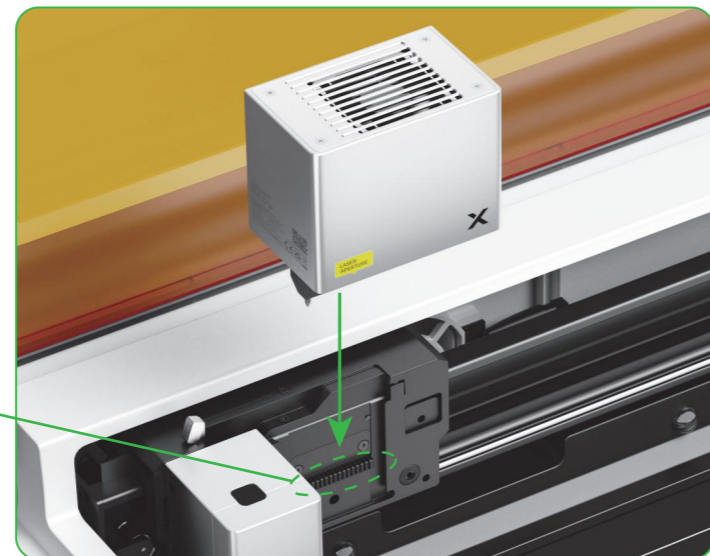

Poussez le module laser vers le bas jusqu'à entendre un clic.



3



N'utilisez pas le module d'évacuation de fumée sans le filtre. Il risquerait d'absorber de la fumée et de la poussière, et de subir des dégâts.

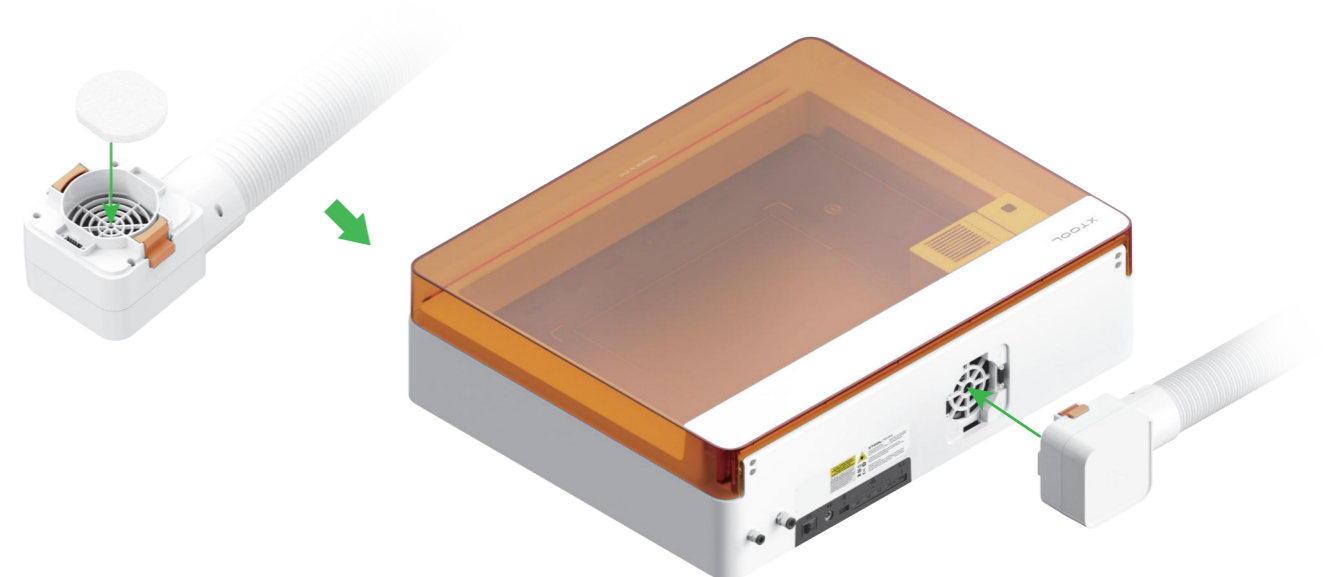

4

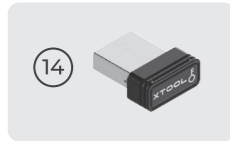

Insérez la clé pour déverrouiller le traitement et les fonctions associées. Vous pouvez retirer la clé pour verrouiller le traitement et les fonctions associées.

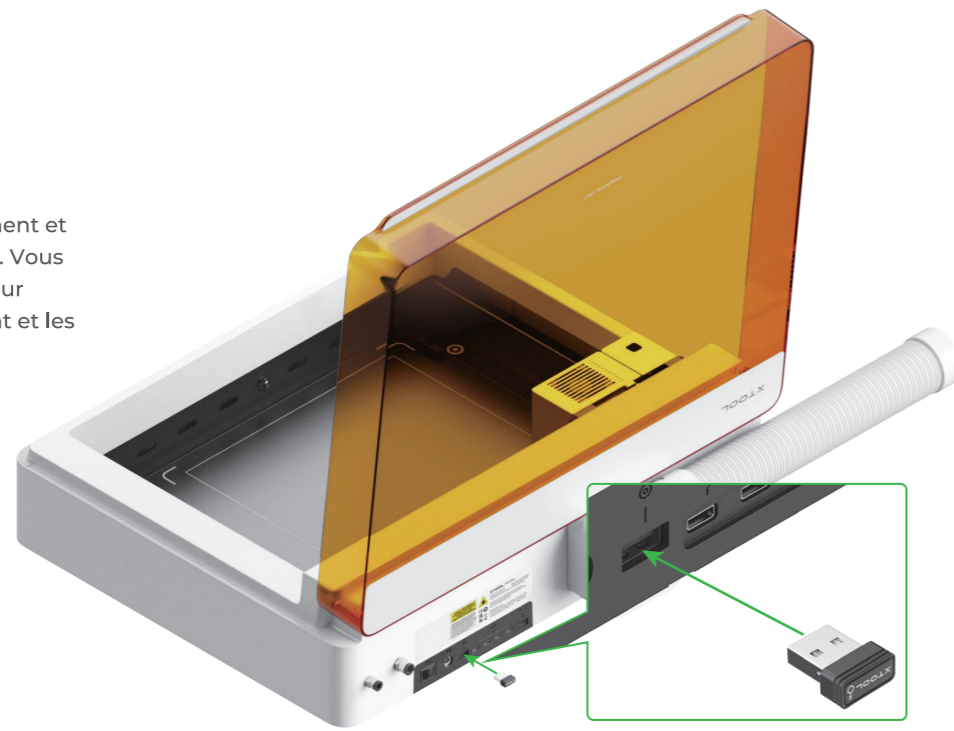

5

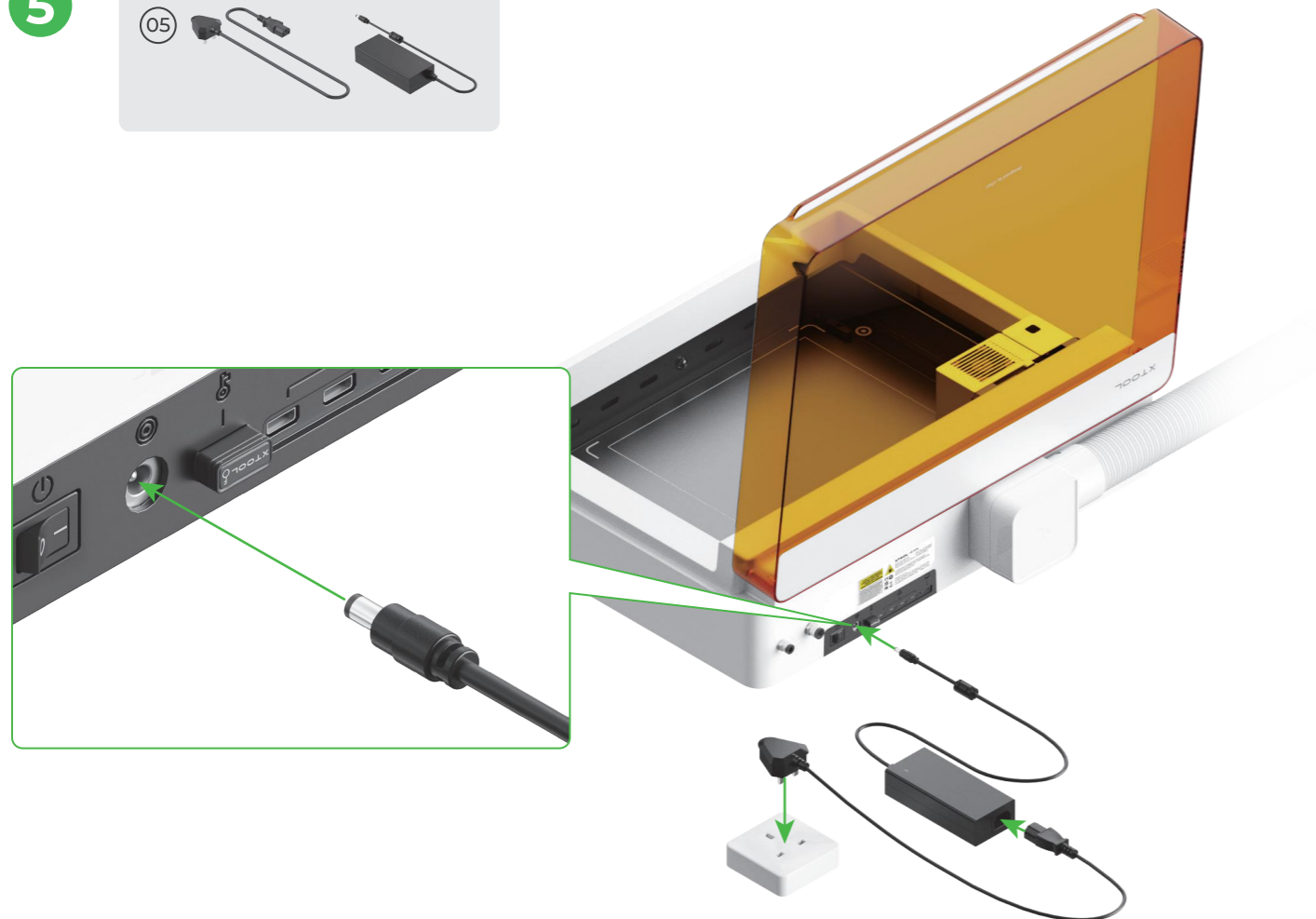
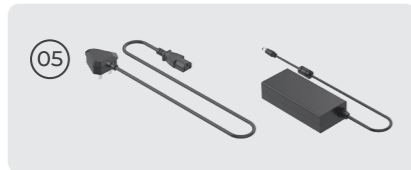

6



Accédez à xtool.com/software pour télécharger et installer xTool Creative Space (XCS).

Recherchez **xTool Creative Space** dans un magasin d'applications ou scannez le code QR suivant pour le téléchargement de l'application.

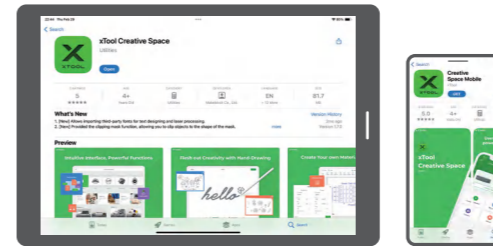

7

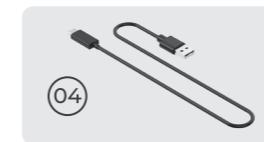

Activez le xTool M1 Ultra, connectez-le à un dispositif, puis à XCS.

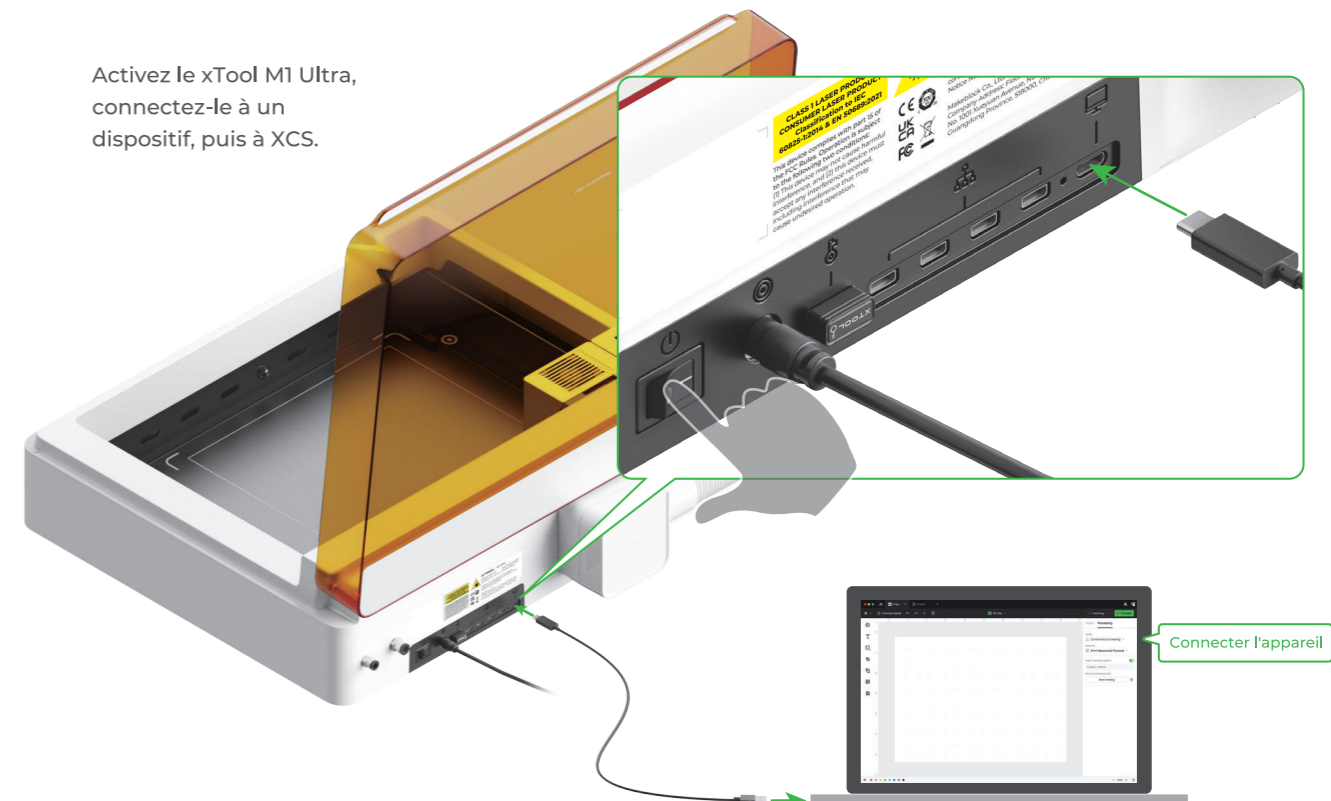

Pour plus de détails, scannez le code QR suivant.



support@xtool.com

Utiliser xTool M1 Ultra

Pour la coupe laser

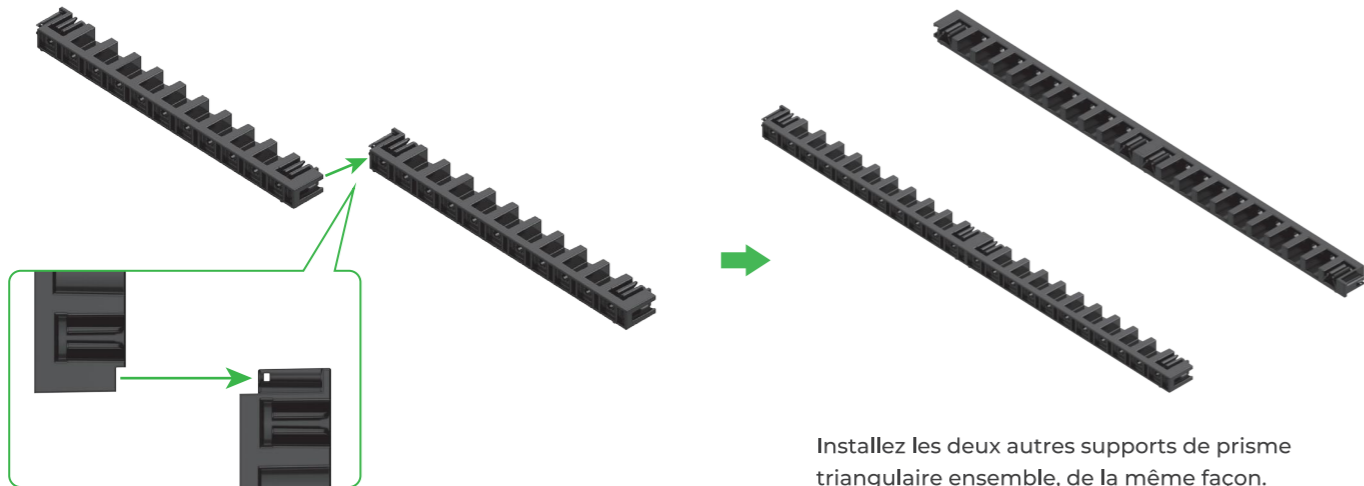
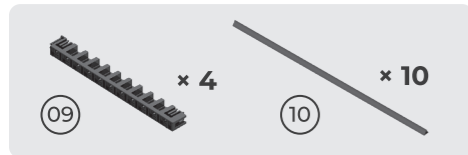

Installez les deux autres supports de prisme triangulaire ensemble, de la même façon.

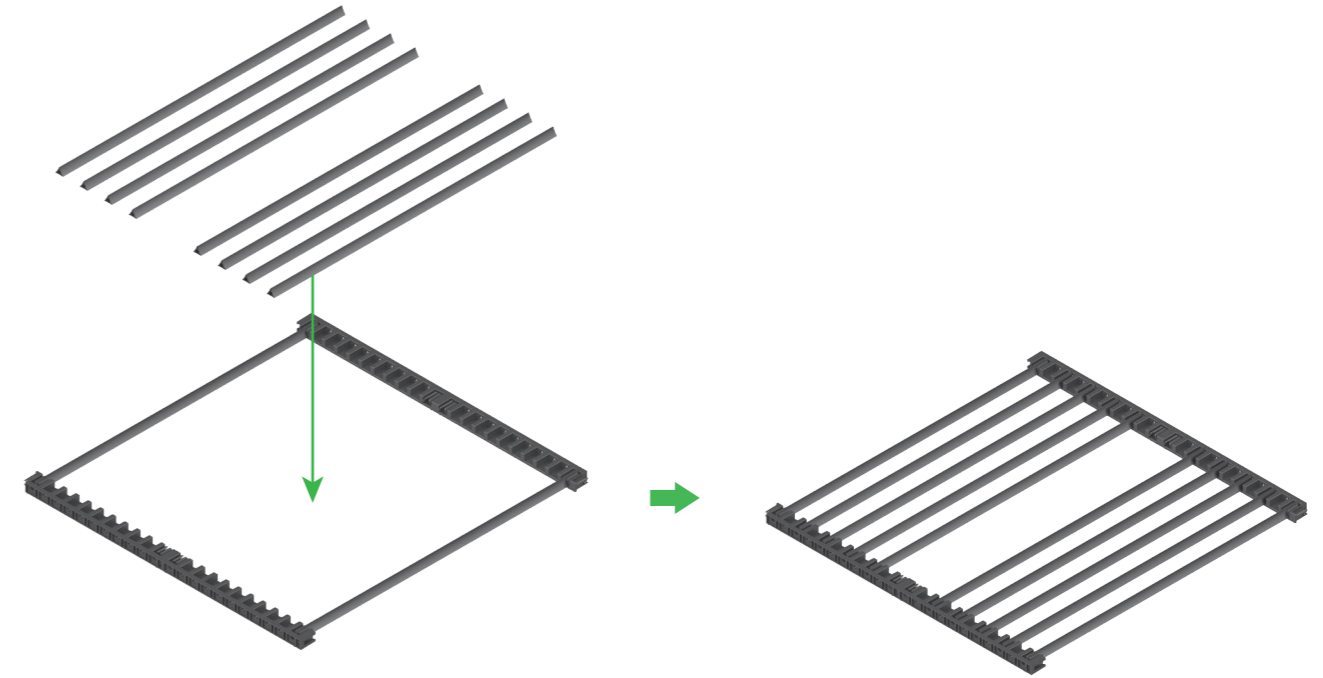
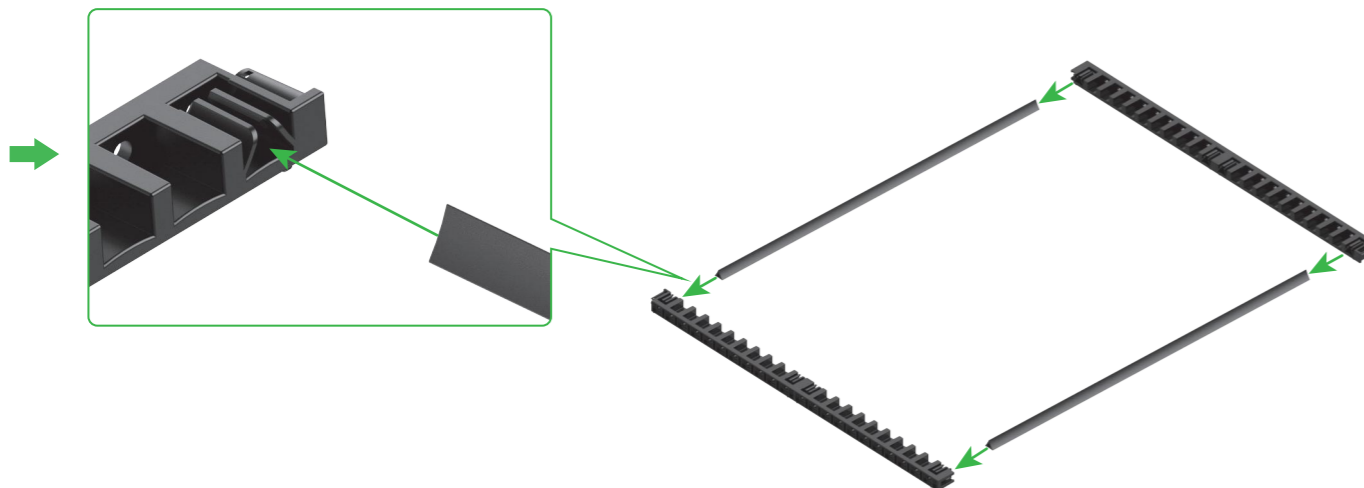

Déterminez le nombre de prismes triangulaires en fonction du matériau à traiter.

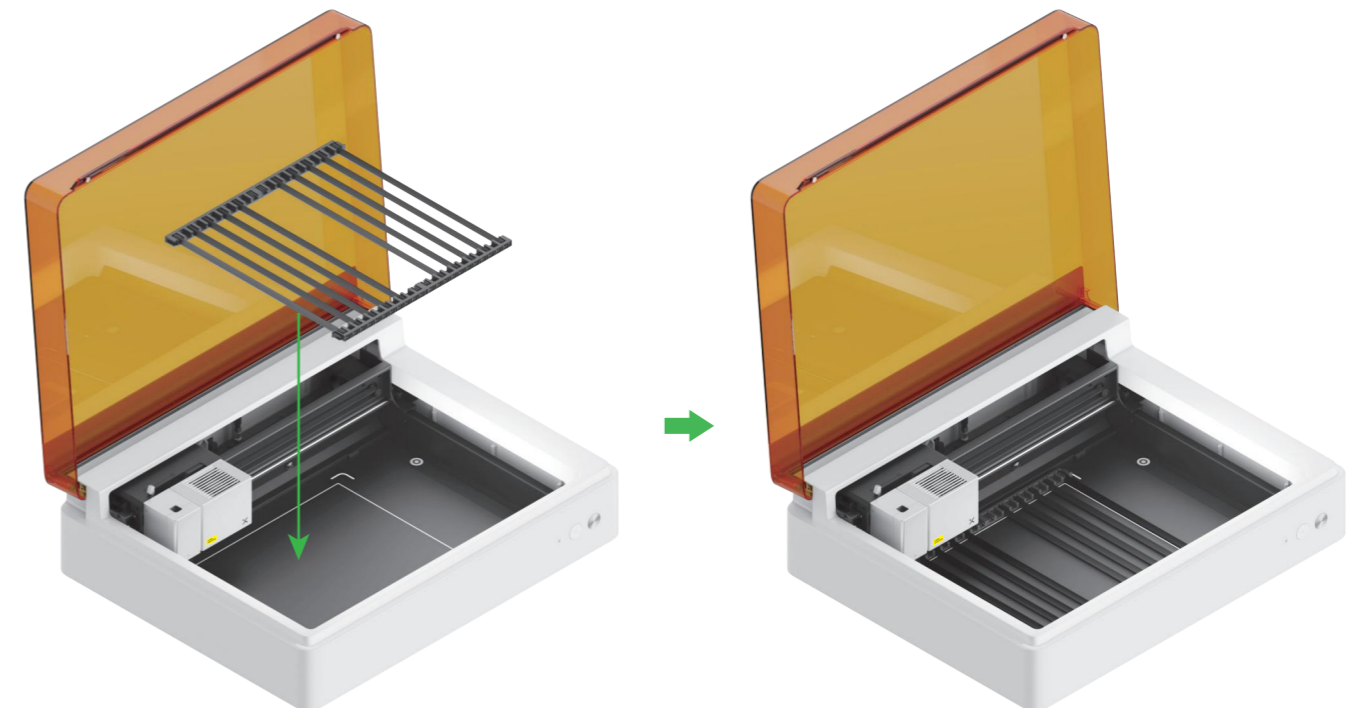

Pour la coupe avec lame ou une association de traitement laser et de coupe avec lame

1

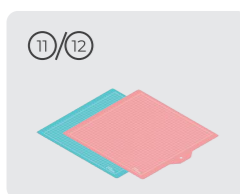

Remarque : Pour les matériaux en papier, comme le carton et le papier kraft, utilisez le tapis de coupe LightGrip. Pour les matériaux en tissu, utilisez le tapis de coupe FabricGrip. N'utilisez pas de tapis de coupe pour couper un matériau avec des rayons laser.

Tapis de coupe		
Couleur	Bleu	Rose
Applicable à	Matériaux légers	Tissus
Matériau	Carton, Papier d'emballage, Papier d'impression Papier kraft, Papier nacré	Tissu

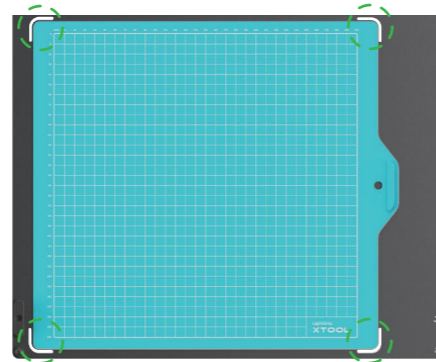
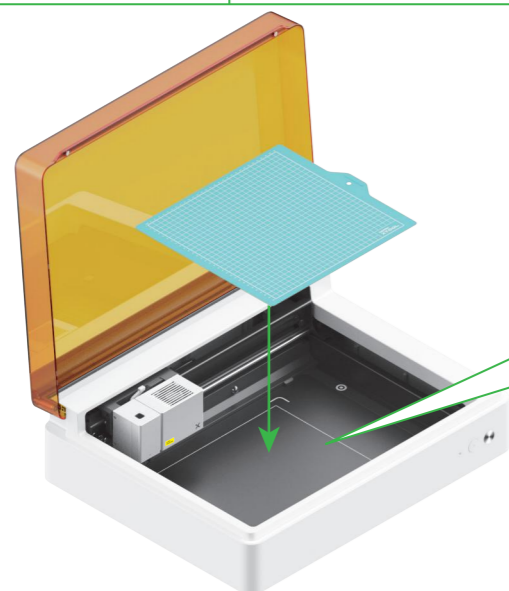

Retirez le film protecteur avant d'utiliser le tapis de découpe.
Lorsque vous placez le tapis de coupe, alignez-le sur les repères situés aux quatre coins de la plaque de base.

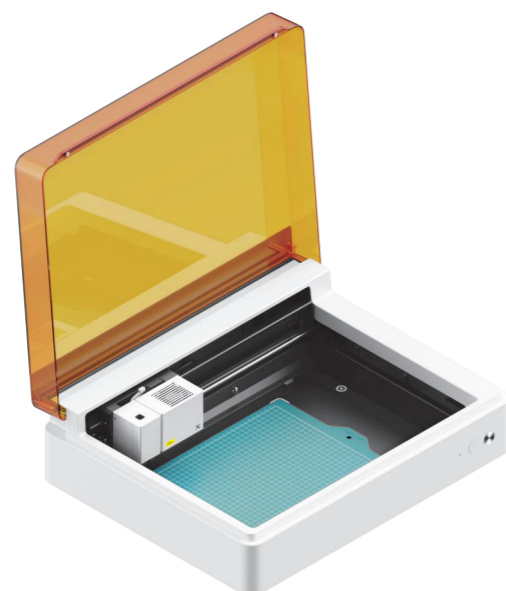

2

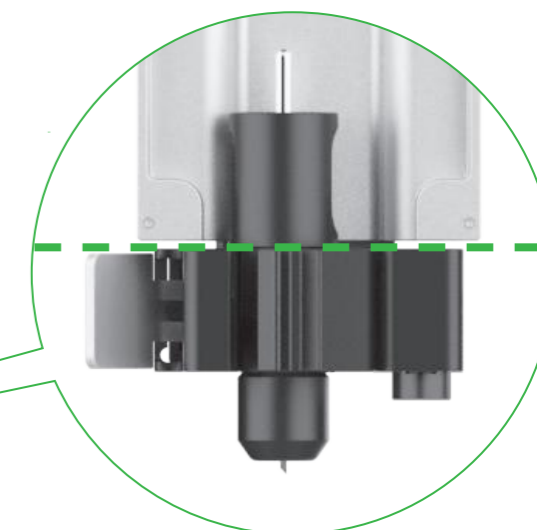
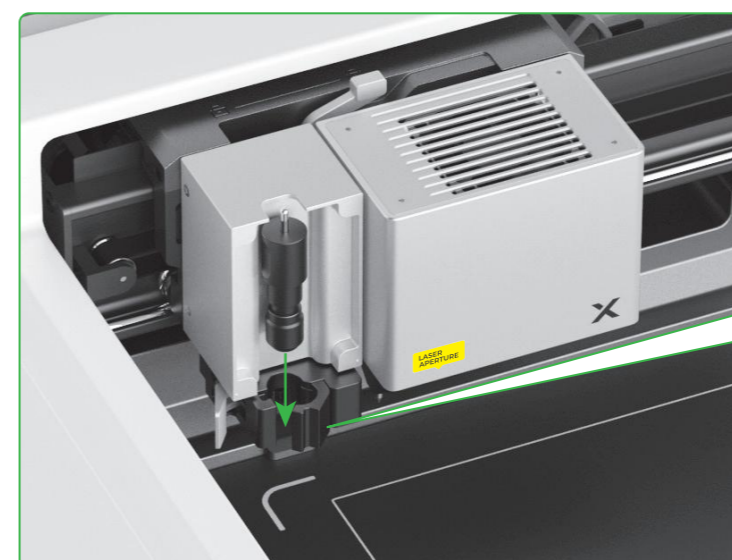
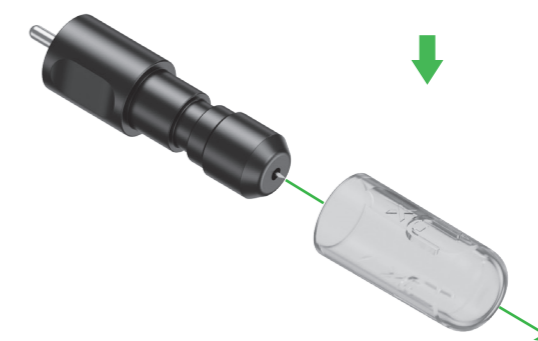
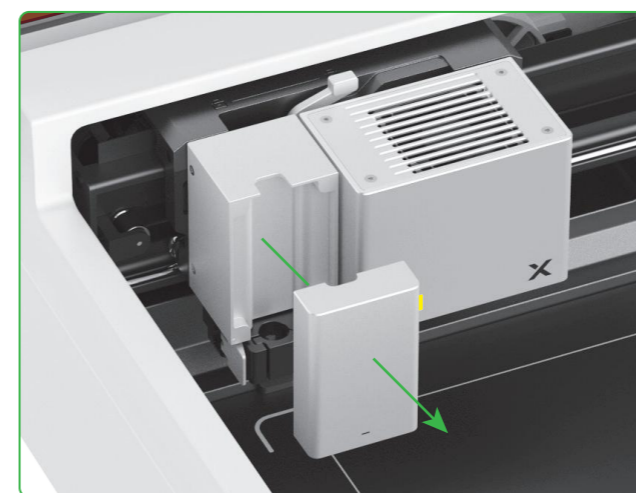

Attention !
Lame tranchante

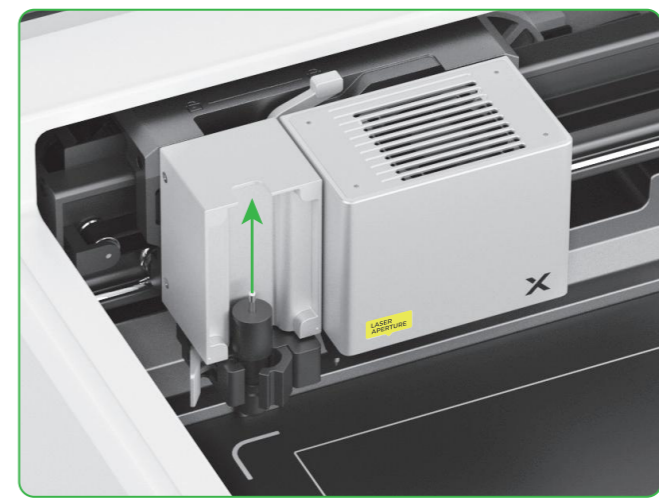
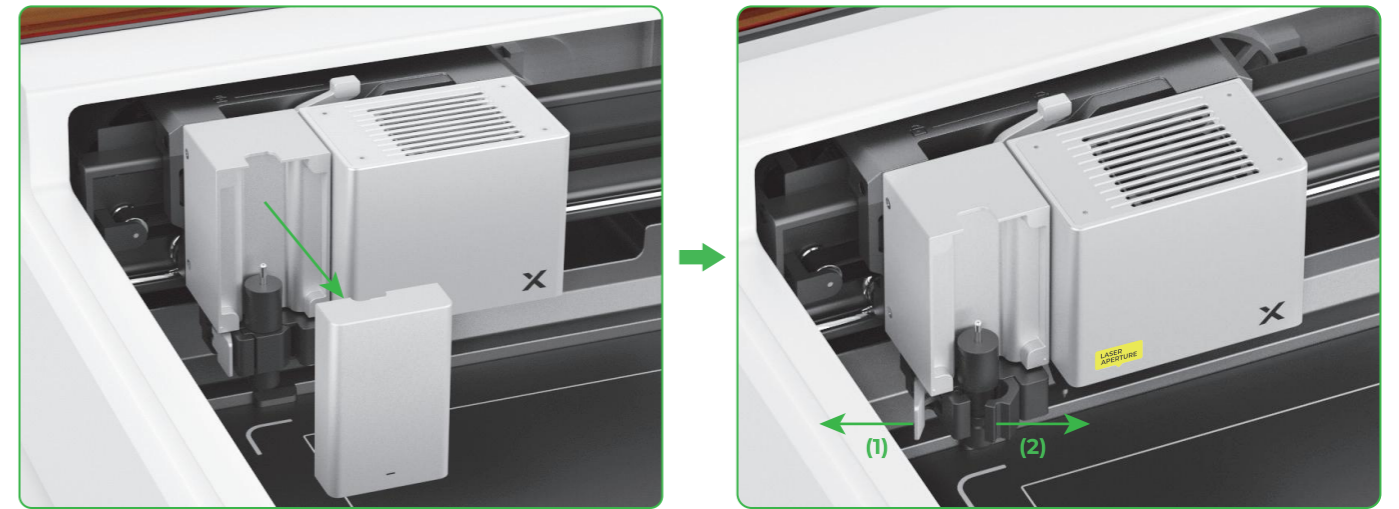
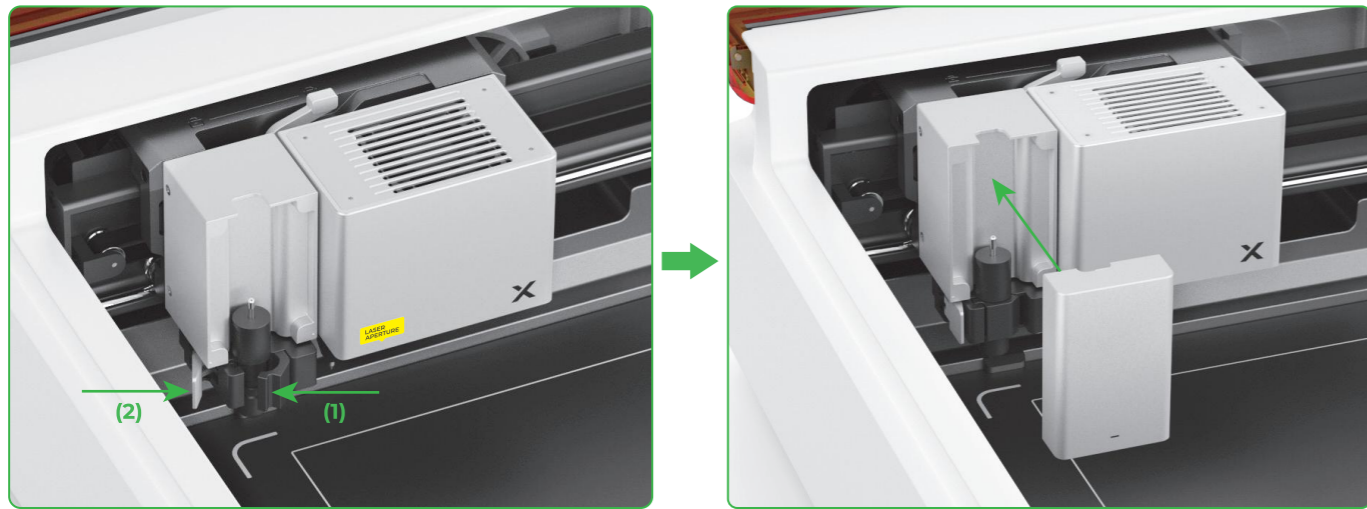

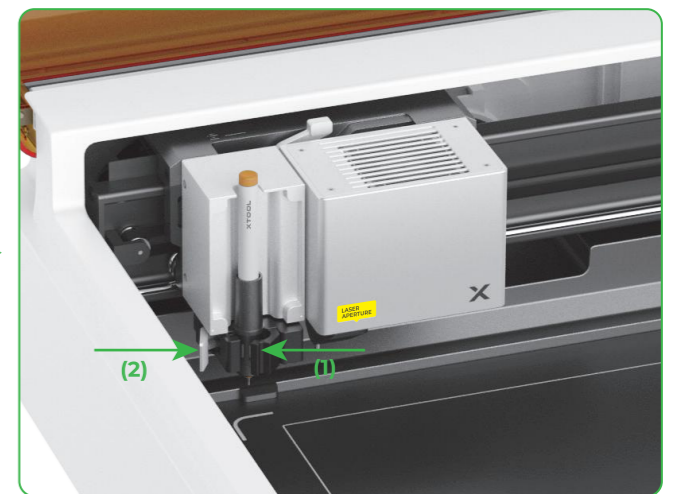
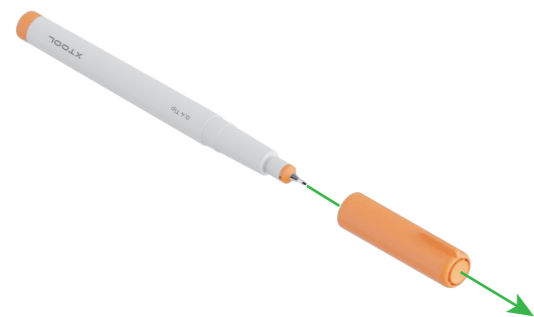

Attention !
Lame tranchante

Pour le dessin avec un stylo

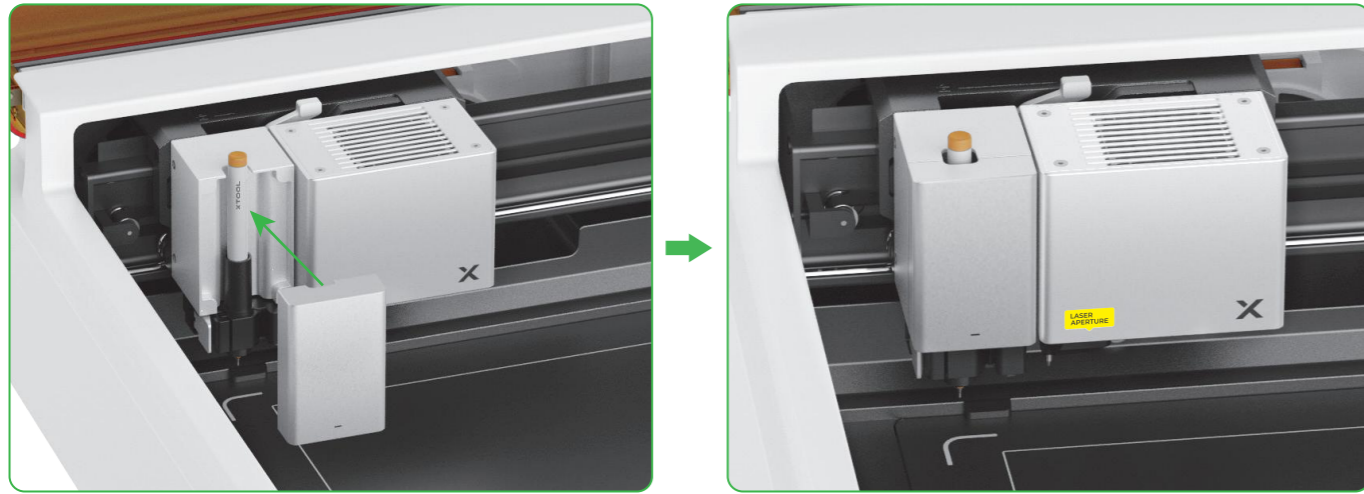

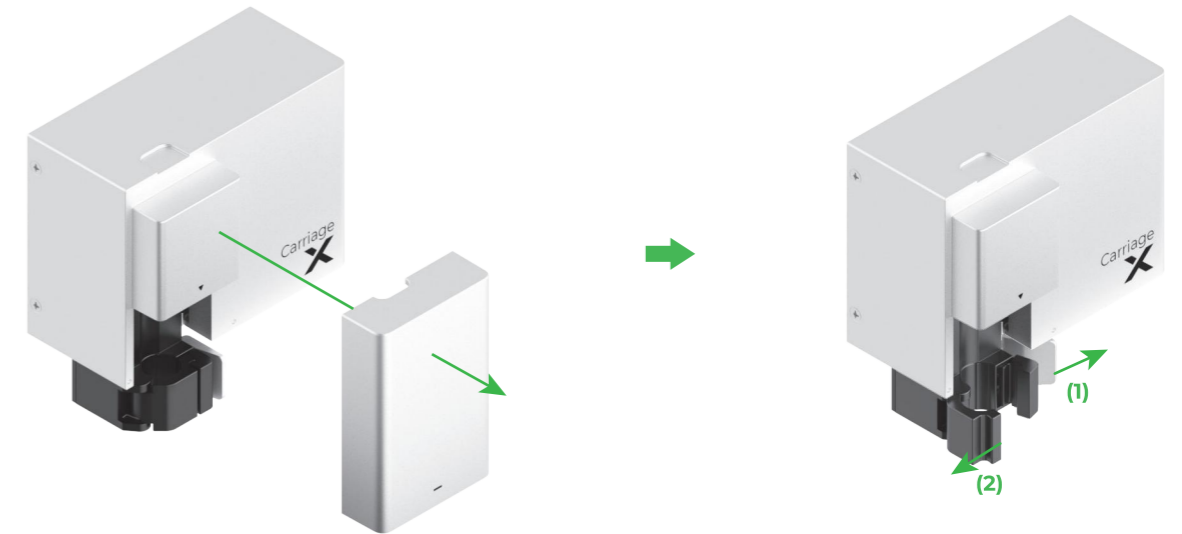
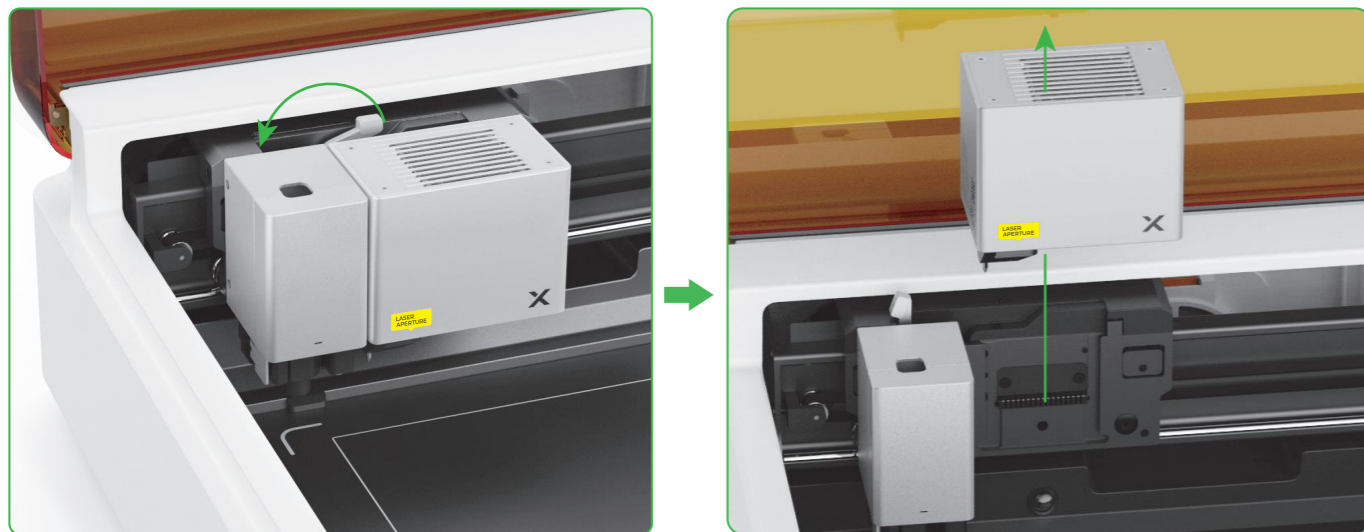
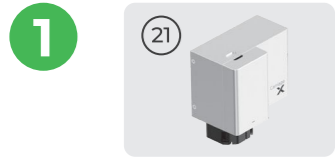

Pour plus de fonctions



2 Sélectionnez les accessoires en fonction des besoins liés au traitement.

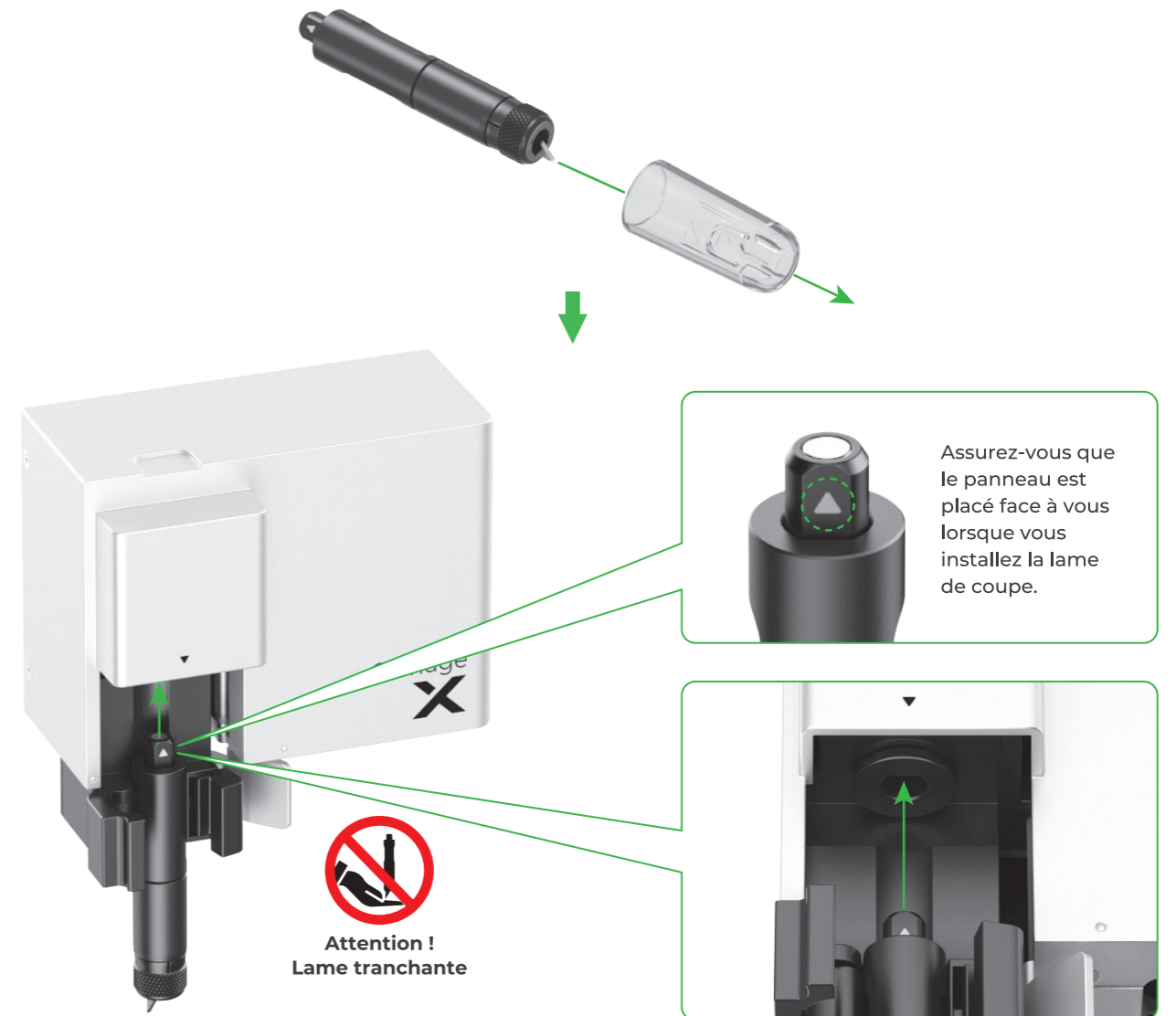

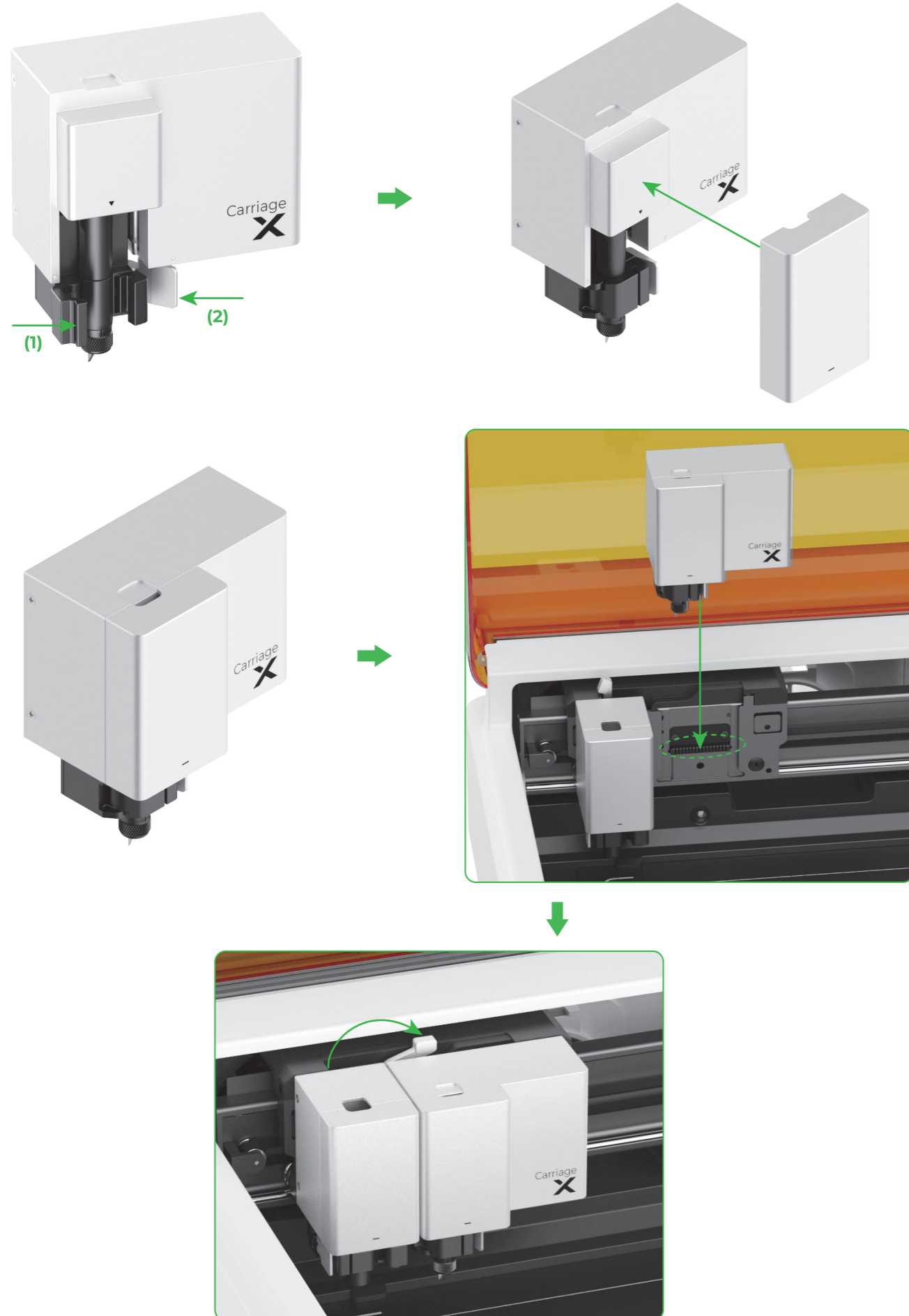

Description de l'indicateur

État du voyant	État du signal sonore	État de la machine
○ Blanc fixe	/	En attente, non connecté à XCS (en mode AP)
○ Bleu clair uni	/	En attente, non connecté à XCS (en mode STA)
○ Violet fixe	Sonne une fois	En attente, connecté à XCS
○ Clignotement blanc	/	En veille, non connecté à XCS
○ Clignotement violet	/	En veille, connecté à XCS
○ Clignotement lent violet	/	Mise à jour du micrologiciel
○ Vert fixe	/	Traitement du marquage de la zone sur XCS / Cadrage / Traitement
○ Clignotement lent bleu	Sonne une fois	Prêt pour le cadrage / Prêt pour le traitement
○ Bleu uni	/	Tâche en pause
○ Clignotement jaune	Sonne une fois	Le couvercle est ouvert ou n'est pas entièrement fermé pendant le fonctionnement.
○ Clignotement jaune	Continue à sonner	Flamme détectée (petite flamme) / Appareil secoué
○ Clignotement rouge	Continue à sonner	Flamme détectée (grande flamme)
○ Clignotement jaune	Sonne trois fois	Des exceptions se produisent
○ Clignotement rouge	Sonne trois fois	Des exceptions majeures se produisent